

# 9. Supermarket



Barcelona - Spain

# Waterin



254-257

Serie / Series / Série

# VMD Madrid



VMD RU/SU  
VMD R/S  
VMD C / M 258-263

Serie / Series / Série

# VBC Barcelona



VBC R/RU / S/SU  
VBC C / M / MHD  
VBC R/RU CP / S/SU CP  
VBC CP / MP / MHDP  
VBC S CB/SU CB 264-279

Serie / Series / Série

# VEX Experience



VEX CP  
VEX  
VEX CB  
VEX CA / CP HT  
VEX HT7GC/GF 280-291

Serie / Series / Série

# VEE California



VEE  
VEE CA  
VEE HT  
VEE GC  
VEE S  
VEE AAM 292-297

Serie / Series / Série

# VCT Compact



VCT CP  
VCT CB  
VCT HT/GC 298-307

Serie / Series / Série

# SVT Compact



SVT R14  
SVT R  
SVT HT 308-317

Serie / Series / Série

# VCL Colombia



VCL CP 318-323

Serie / Series / Série

# VVS/VVL Visión/Valencia



VVS  
VVL 324-325

Serie / Series / Série

# VPG Biggie



VPG37 326-327

Serie / Series / Série

# GD/COMBI



GD P  
AS25U 328-331

## 8. Supermarket

Estructura de cristales de alta transparencia, rectos o curvos según modelo.

High transparency glass structure, flat or curved depending on the model.

Structure en verre à haute transparence, droite ou bombée selon le modèle.

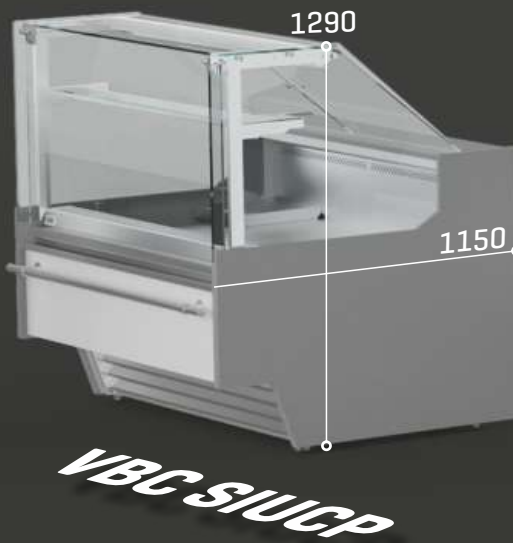
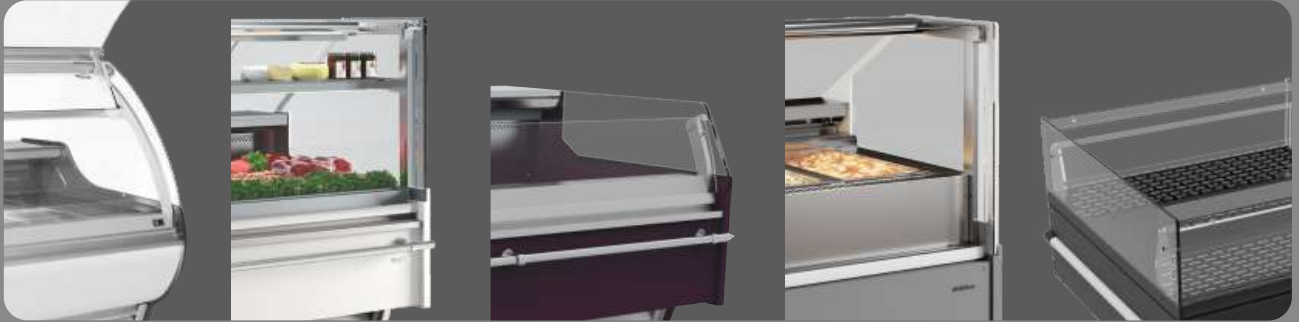

### Iluminación / Lighting / Éclairage

Incorporación de iluminación LED, llegando a reducir el consumo energético entre un 80% y 90%, respecto a una bombilla tradicional.

LED lighting incorporated, reducing energetic consumption between 80% and 90% respect to a traditional light bulb.

Éclairage LED, réduisant la consommation énergétique entre 80% et 90%, par rapport à une ampoule traditionnelle.



Equipos con posibilidad de grupo remoto y grupo incorporado.

Devices with the possibility of remote group and integrated group.

Équipement avec la possibilité de groupe à distance et de groupe incorporé.



**VIE CA**

**VVS**

Máxima visibilidad de producto expuesto.

Maximum visibility of displayed product.

Visibilité maximale du produit exposé.



Amplia gama de opciones y posibilidades de personalización para exponer todo tipo de productos refrigerados sin envasar: carne, charcutería y delicatessen.

Wide range of options and customisation possibilities for displaying all types of unpackaged refrigerated products: meat, deli and delicatessen.

Nombreuses options et possibilités de personnalisation pour présenter tous les types de produits réfrigérés non emballés : viande, charcuterie et delicatessen.



# Waterin

## Sistema Waterloop R290 de Infrico

hasta  
**-25%**

Sistema eficiente, hasta el 25% de ahorro de energía.  
Efficient system with up to 25% energy saving.  
Système efficace avec jusqu'à 25 % d'économies d'énergie.

**-75%**

75% reducción carga refrigerante.  
75% refrigerant charge reduction.  
Réduction de 75 % de la charge de réfrigérant.

**0€**

Refrigerantes naturales  
SIN TASA.  
Natural refrigerants WITHOUT CHARGE.  
Réfrigérateurs naturels  
SANS TÂCHE.



Mínima carga refrigerante, aprox. 0.1kg/kw.  
Minimum refrigerant load, aprox. 0.1kg/kw.  
Charge minimale de réfrigérant, avec environ 0,1 Kg/kw de réfrigération.

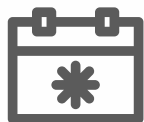

Flexibilidad de implantación.  
Flexibility of implementation.  
Flexibilité de mise en oeuvre.



Posibilidad de recuperación de calor en la instalación.  
Possibility of heat recovery in the installation.  
Possibilité de récupération de chaleur dans l'installation.



Condensadores sin mantenimiento.  
Maintenance-free condensers.  
Condensateurs de maintenance.



Posible eliminación de la sala de máquinas.  
Possible elimination of the machine room.  
Élimination possible, dans de nombreux cas, de la salle des machines.



Eliminación de riesgos típicos de inst. centralizadas.  
Elimination of the typical risks of central installations.  
Élimination des risques typiques des installations centralisées.



Menor riesgo de fugas.  
Reduced risk of leakage.  
Moins de risques de fuites.



El ahorro energético y el cuidado del medio ambiente son dos factores claves que han impulsado la iniciativa Waterin.

#### ¿Qué es Waterin?

Waterin son muebles de refrigeración comercial para la conservación de productos refrigerados y congelados, con unidades individuales R290 y sistema de condensación por agua.

#### ¿Dónde podemos instalar este sistema?

Este sistema es óptimo para instalaciones que cumplan los siguientes condicionantes:

- Sala de ventas de hasta 1400m<sup>2</sup> con aproximadamente hasta 40kW frigoríficos.
- Temperatura de trabajo exterior (DryCooler) máxima de 48°C.

#### ¿Este nuevo sistema requiere un proyecto de instalación?

El sistema Waterin no requiere instalación frigorífica porque son muebles con la unidad ya instalada y cargada desde fábrica, aunque su implantación requiere un cálculo de instalación para el dimensionado de las tuberías de agua, el DryCooler, el sistema hidráulico necesarios y su ubicación, etc.

#### Beneficios del sistema Waterin

Waterin por ser un sistema ecológico y de condensación por agua ofrece múltiples beneficios en la refrigeración comercial. Mayor eficiencia energética, menor impacto ambiental y mejor control de temperatura son sólo algunas de sus ventajas.



Saving energy and respect for the environment are two key factors that have driven the Waterin initiative.

#### What's Waterin?

Waterin are commercial refrigeration display cases for the preservation of refrigerated and frozen products, with individual R290 units and water condensation system.

#### Where do we install this system?

This system is ideal for installations that meet the following conditions:

- Supermarkets up to 1400m<sup>2</sup> with approximately up to 40kW of refrigeration capacity.
- Outdoor working temperature (DryCooler) max. 48°C.

#### Is an installation project required?

The Waterin system doesn't require refrigeration installation because it's display cases with the unit already installed and loaded from the factory, although its implementation requires an installation calculation for the dimensioning of the water pipes, the DryCooler, the necessary hydraulic system and its location, etc.

#### Benefits of Waterin

Waterin is an environmentally friendly, water condensing system that offers multiple benefits in commercial refrigeration. Greater energy efficiency, lower environmental impact and better temperature control are just some of its advantages.



Les économies d'énergie et le respect de l'environnement sont deux facteurs qui ont motivé l'initiative Waterin.

#### Qu'est-ce que Waterin?

Waterin est une armoire de réfrigération commerciale pour les températures positives et négatives de stockage des produits, avec des unités R290 individuelles et un système de condensation à l'eau.

#### Où peut-on installer ce système?

Ce système est optimal pour les installations qui répondent aux conditions suivantes :

- Salle de vente jusqu'à 1400 m<sup>2</sup> avec environ jusqu'à 40kW d'unités de réfrigération
- Température extérieure de travail (DryCooler) maximale de 48°C.

#### Ce nouveau système nécessite-t-il un projet d'installation?

Le système Waterin ne nécessite pas d'installation frigorifique car il s'agit d'un meuble avec l'unité déjà installée et chargée en usine, bien que sa mise en œuvre dans la salle de vente nécessite un calcul de l'installation du système de condensation de l'eau et de ses composants.

#### Quels sont les avantages du système Waterin ?

Waterin est un système écologique à condensation par eau qui offre de multiples avantages dans le domaine de la réfrigération commerciale. Une meilleure efficacité énergétique, un impact environnemental réduit et un meilleur contrôle de la température ne sont que quelques-uns de ses avantages.



# Waterin

## Sistema Waterloop R290 de Infrico

Unidades R290 condensados por agua de Temperatura Positiva.  
R290 units, Positive Temperature water condensed.  
Unités R290 à condensation par eau à Température Positive.

Unidades R290 condensados por agua de Temperatura Negativa.  
R290 units, Negative Temperature water condensed.  
Unités R290 à condensation par eau à Température négative.

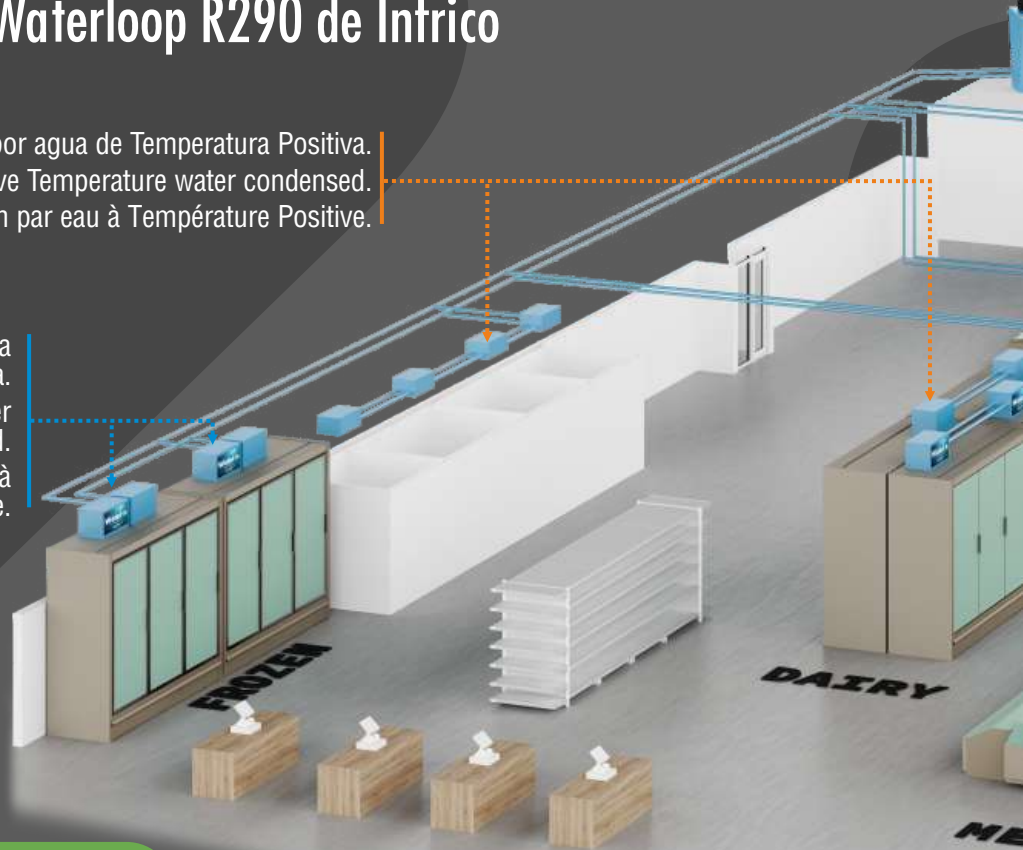

Posibilidad de recuperación de calor para calefacción o agua caliente sanitaria.

Possibility of heat recovery for heating or sanitary hot water.

Possibilité de récupération de chaleur pour le chauffage ou l'eau chaude sanitaire.

Unidades R290 condensados por agua de Temperatura Positiva.  
R290 units, Positive Temperature water condensed.  
Unités R290 à condensation par eau à Température Positive.

9



VEXW

VEX (9-12-18-25-31-37) W-IW  
VEX (9-12-18-25-31-37) WCP-IWCP  
VEX (9-12-15-18-25) WCB-IWCB  
VEX (90) AAW-ACW-AIW-ACIW  
VEX (45) ACW-ACIW  
VEX (90) AAWCP-ACWCP-AAIWCP-ACIWCP  
VEX (45) ACWCP-ACIWCP

Dry Coolers con grupo hidráulico.  
 Dry Coolers with hydraulic power unit.  
 Dry Coolers avec unité hydraulique.

Unidades R290 condensados por agua de Temperatura Negativa.  
 R290 units, Negative Temperature water condensed.  
 Unités R290 à condensation par eau à Température négative.

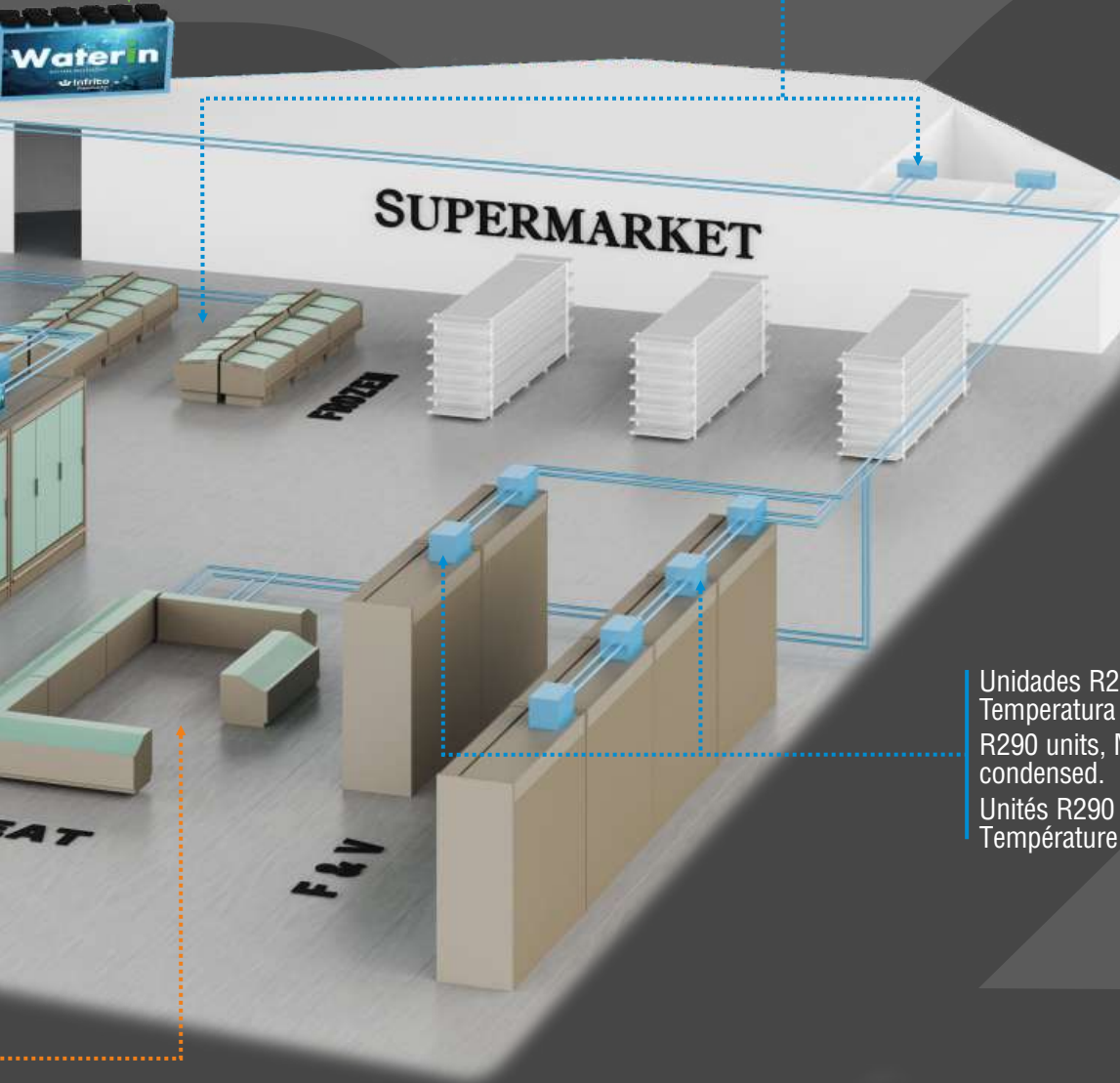

Unidades R290 condensados por agua de Temperatura Negativa.  
 R290 units, Negative Temperature water condensed.  
 Unités R290 à condensation par eau à Température négative.



**GDW**

GD25WL1  
 GD21WL1  
 GDCWL1



**AS25W**

AS25WL1



# VBC

## Vitrina expositora modular frío ventilado / Refrigerated modular display case / Vitrine présentation froid ventilé canalisable

### CARACTERÍSTICAS

Vitrina remota/grupo incorporado (U), con reserva (R)/sin reserva (S), de cristal curvo para servicio asistido.  
Diseñada para carnes y alimentos precocinados ya envasados, charcutería, lácteos y sándwiches.  
Sistema de refrigeración ventilado.  
Reserva refrigerada para multiplicar las opciones del servicio de venta (R).  
Encimera de trabajo ergonómica en acero inoxidable AISI304.  
Estante intermedio de cristal templado.  
Encimera superior de cristal templado.  
Exposición en acero inox. AISI304 (I).  
Decoración en chapa lacada según carta de colores.  
Vidrios frontales elevables.  
Estructura y soporte de cristales en perfilera de aluminio anodizado.  
Equipamiento de alta eficiencia:  
- Iluminación doble LED color carne en exposición.  
- Iluminación LED decorativa blanco frío 6000K.  
- Ventiladores electrónicos.

### MAIN FEATURES

Remote display case/plug in (U), with storage (R)/without storage (S), curved glass for assisted service.  
Designed for pre-packed meats and convenience foods, deli, dairy and sandwiches.  
Ventilated refrigeration system.  
Refrigerated reserve to multiply vending options (R).  
Ergonomic worktop in AISI304 stainless steel.  
Intermediate shelf in tempered glass.  
Upper worktop in tempered glass.  
Stainless steel display. AISI304 (I).  
Lacquered steel plate decoration according to colour chart.  
Flip-up front glass.  
Structure and glass support in anodised aluminium profiles.  
High efficiency equipment:  
- Double meat-coloured LED lighting on display.  
- 6000K cool white decorative LED lighting.  
- Electronic fans.

### CARACTERISTIQUES

Vitrine à distance/groupe incorporé (U), avec réserve (R)/sans réserve (S), verre bombée pour service assisté.  
Conçu pour les viandes préemballées et les plats cuisinés, la charcuterie, les produits laitiers et les sandwiches.  
Système de réfrigération ventilé.  
Réserve réfrigérée pour multiplier les possibilités de distribution (R).  
Plan de travail ergonomique en acier inoxydable AISI304.  
Étagère intermédiaire en verre trempé.  
Plan de travail supérieur en verre trempé.  
Présentoir en acier inoxydable AISI304 (I).  
Décoration en acier laqué selon le nuancier.  
Verre frontal relevable.  
Structure et support du verre en profilés d'aluminium anodisé.  
Équipement à haut rendement :  
- Double éclairage LED couleur chair sur le présentoir.  
- Éclairage décoratif à LED blanc froid 6000K.  
- Ventilateurs électroniques.



VBC 37 RU

Serie / Series / Série

**VBC  
BARCELONA**

**RU/RIU/SU/SIU: Grupo Incorporado / Plug in / Groupe incorporé  
R/RI/S/RI: Grupo Remoto / Remote / Groupe à distance**



**CON RESERVA / WHIT STORAGE / AVEC RÉSERVE - RIU/RI: Plano Inox / Stainless Steel exhibition plan / Plan d'exposition Inox**  
**VBC 9 RU/RIU    VBC 12 RU/RIU    VBC 15 RU/RIU    VBC 18 RU/RIU    VBC 25 RU/RIU    VBC 31 RU/RIU    VBC 37 RU/RIU**  
**VBC 9 R/RI    VBC 12 R/RI    VBC 15 R/RI    VBC 18 R/RI    VBC 25 R/RI    VBC 31 R/RI    VBC 37 R/RI**

**SIN RESERVA / WHITOUT STORAGE / SANS RÉSERVE - SIU/SI: Plano Inox / Stainless Steel exhibition plan / Plan d'exposition Inox**  
**VBC 9 SU/SIU    VBC 12 SU/SIU    VBC 15 SU/SIU    VBC 18 SU/SIU    VBC 25 SU/SIU    VBC 31 SU/SIU    VBC 37 SU/SIU**  
**VBC 9 S/SI    VBC 12 S/SI    VBC 15 S/SI    VBC 18 S/SI    VBC 25 S/SI    VBC 31 S/SI    VBC 37 S/SI**



**CON RESERVA / WHIT STORAGE / AVEC RÉSERVE    MUEBLE CAJA / COUNTER CASE / MEUBLE DE COMPTOIR**  
**RIU/RI: Plano Inox / Stainless Steel exhibition plan / Plan d'exposition Inox    VBC 9 C    VBC 12 M    VBC 15 M    VBC 12 MHD**  
**VBC 90 AA RU/RIU    VBC 45 AA RU/RIU    VBC 90 AC RU/RIU    VBC 45 AC RU/RIU**  
**VBC 90 AA R/RI    VBC 45 AA R/RI    VBC 90 AC R/RI    VBC 45 AC R/RI**

**SIN RESERVA / WHITOUT STORAGE / SANS RÉSERVE**  
**SIU/SI: Plano Inox / Stainless Steel exhibition plan / Plan d'exposition Inox**  
**VBC 90 AA SU/SIU    VBC 45 AA SU/SIU    VBC 90 AC SU/SIU    VBC 45 AC SU/SIU**  
**VBC 90 AA S/SI    VBC 45 AA S/SI    VBC 90 AC S/SI    VBC 45 AC S/SI**

# Modelos

Serie/Series/Série **VBC BARCELONA**



VBC 15 RU

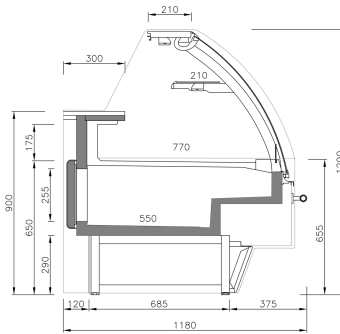

VBC RU/RIU (con reserva)  
[Whit storage]  
[Avec réserve]

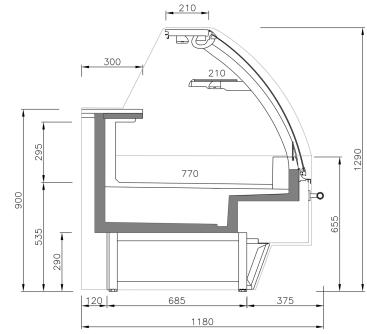

VBC SU/SIU (Sin reserva)  
[Whitout storage]  
[Sans réserve]



ÁNGULOS / ANGLES / ANGLES VBC

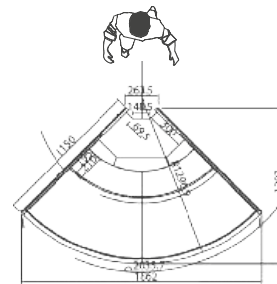

VBC 90 AA RU/RIU  
VBC 90 AA SU/SIU

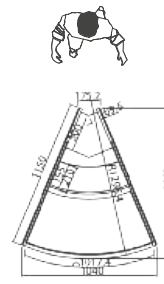

VBC 45 AA RU/RIU  
VBC 45 AA SU/SIU

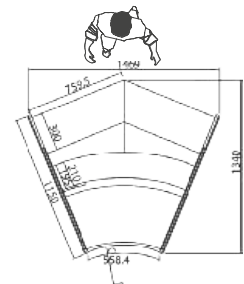

VBC 45 AC RU/RIU  
VBC 45 AC SU/SIU

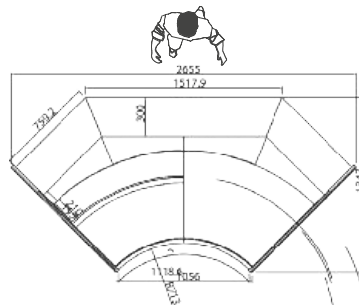

VBC 90 AC RU/RIU  
VBC 90 AC SU/SIU

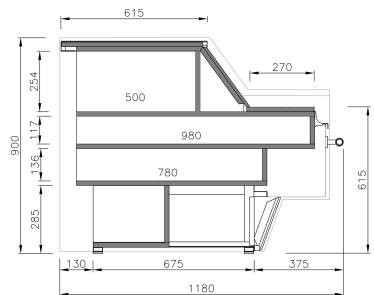

VBC C/M



VBC12M

**Colores fuera de carta /**  
Colors outside of letter /  
Couleurs spéciales, hors palette

RAL		NO RAL	
Epoxi	Líquida/ Liquid/ Liquide	Epoxi	Líquida/ Liquid/ Liquide
		Consultar / Consulter / Consulter	
+10 días laborables / +10 work days / +10 jours ouvrés		Consultar / Consulter / Consulter	

**Laterales / Sides / Joues**

NO	
Izquierdo Left Gauche	Derecho Right Droite

**Laterales / Sides / Joues**

**VBC C/M/MHD: SÍ**

**Int. Estándar / Standar / Standard**

Blanco/White/ Blanc	Negro/Black/ Noir	Ral 7016	INOX [I/HT/GC]
------------------------	----------------------	----------	-------------------















**Ext. Estándar / Standar / Standard**

Blanco/White/ Blanc	Ral 1015	Ral 1018	Ral 2003	Ral 3003	Ral 3020	Ral 5015
Ral 5017	Ral 5011	Ral 8002	Ral 6018	Ral 6019	Ral 7035	Ral 7037
Ral 7042	Ral 7016	Ral 9006	Ral 7013	Negro/Black/ Noir	Roble natural	

# VBC U

Vitrina expositora modular frío ventilado grupo incorporado /  
Refrigerated modular plugin display case /  
Vitrine présentation froid ventilé canalisable groupe incorporé















CON RESERVA / WHIT STORAGE / AVEC RÉSERVE - RIU: Plano Inox / Stainless Steel exhibition plan / Plan d'exposition Inox

MODELO MODELE MODÈLE								
Precio Price Prix	RU							
	RIU							
	SIN RESERVA / WHITOUT STORAGE / SANS RÉSERVE - SIU: Plano Inox / Stainless Steel exhibition plan / Plan d'exposition Inox							
MODELO MODELE MODÈLE								
Precio Price Prix	SU							
	SIU							
Medidas Measures Mesures	(mm)	938 x 1150 x 1290 mm.	1250 x 1150 x 1290 mm.	1562 x 1150 x 1290 mm.	1875 x 1150 x 1290 mm.	2500 x 1150 x 1290 mm.	3125 x 1150 x 1290 mm.	3750 x 1150 x 1290 mm.
Temperatura Temperature Température	(°C)	0°C/+6°C						
Clase Climática Climatic class Classe climatique	(°C)	4 / 30°C						
Tensión/Frecuencia Electrical data Tension électrique		230V/1ph/50Hz						
Controlador Controller Régulateur		Digital						
Material Matériel	[EXT/INT]	Ext: acero plastificado / Plastified stainless steel / Acier plastifié Encimera / Worktop / Dessous: Inox Aisi 304 Plano exposición / Exhibition plan / Plan d'exposition: Acero plastif. / Plastif. Stainless steel/ Acier plastifié (Mod RU/SU) - Inox Aisi 304 (Mod. RIU/SIU)						
Aislamiento Isolation Isolation		40kg/m <sup>3</sup> / Free CFC's / Zero ODP-GWP						
Capacidad Capacity Capacité	(L)	82	109	137	164	219	273	328
Superficie exposición Surface exhibition Surface d'exposition	(m <sup>2</sup> )	0,92	1,23	1,53	1,84	2,45	3,06	3,68
Compresor Compressor Compresseur	(HP)	1/3	1/2	3/4	3/4	1+1/4	1+1/4	1+1/4
Estantes Shelving Étagères		1						
Costados (2) Sides (2) Joues (2)	(mm)	30+30						
Sistema de frío Cooling System Système de froid		Ventilado / Ventilated / Ventilé						
Desescarche Defrost Dégivrage		Automático / Automatic / Automatique						
Evaporación Evaporation Évaporation		Forzada / Forced / Ventilé						
Potencia Power Puissance	(W)	394	531	590	681	1115	2166	2190
Potencia frig. Cooling capacity Puissance Frig.	(W A -10°C)	-	-	-	-	-	-	-
Consumo Consumption Consommation	(kWh/ 24h)	5.18	7.01	7.8	8.9	14.6	28.6	28.9
Refrigerante Refrigerant Gaz		R-290						
Opcional Optional Options								

Laterales no incluidos en el precio  
Side panels not included in price  
Joues non incluses dans le prix

## Vitrina expositora modular frío ventilado grupo remoto / Refrigerated modular display remote case / Vitrine présentation froid ventilé canalisable groupe à distance

CON RESERVA / WITH STORAGE / AVEC RÉSERVE - RI: Plano Inox / Stainless Steel exhibition plan / Plan d'exposition Inox

MODELO MODELE MODÈLE								
Precio Price Prix	R	RI	RI	RI	RI	RI	RI	
	SIN RESERVA / WITHOUT STORAGE / SANS RÉSERVE - SI: Plano Inox / Stainless Steel exhibition plan / Plan d'exposition Inox							
MODELO MODELE MODÈLE								
Precio Price Prix	S	SI	SI	SI	SI	SI	SI	
Medidas Measures Mesures	(mm)	938 x 1150 x 1290 mm.	1250 x 1150 x 1290 mm.	1562 x 1150 x 1290 mm.	1875 x 1150 x 1290 mm.	2500 x 1150 x 1290 mm.	3125 x 1150 x 1290 mm.	3750 x 1150 x 1290 mm.
Temperatura Temperature Température	(°C)	0°C/+6°C						
Clase Climática Climatic class Classe climatique	(°C)	4 / 30°C						
Tensión/Frecuencia Electrical data Tension électrique		230V/1ph/50Hz						
Controlador Controller Régulateur		Digital						
Material Material Matériel	(EXT/INT)	Ext: acero plastificado / Plastified stainless steel / Acier plastifié Encimera / Worktop / Dessous: Inox Aisi 304 Plano exposición / Exhibition plan / Plan d'exposition: Acero plastif./Plastif. Stainless steel/ Acier plastifié [Mod RU/SU] - Inox Aisi 304 [Mod. RIU/SIU]						
Aislamiento Isolation Isolation		40kg/m <sup>3</sup> / Free CFC's / Zero ODP-GWP						
Capacidad Capacity Capacité	(L)	82	109	137	164	219	273	328
Superficie exposición Surface exhibition Surface d'exposition	(m <sup>2</sup> )	0,92	1,23	1,53	1,84	2,45	3,06	3,68
Compresor Compressor Compresseur	(HP)	-	-	-	-	-	-	-
Estantes Shelving Étagères		1						
Costados (2) Sides (2) Joues (2)	(mm)	30+30						
Sistema de frío Cooling System Système de froid		Ventilado / Ventilated / Ventilé						
Desescarche Defrost Dégivrage		Automático / Automatic / Automatique						
Evaporación Evaporation Évaporation		Forzada / Forced / Ventilé						
Potencia Power Puissance	(W)	-	-	-	-	-	-	-
Potencia frig. Cooling capacity Puissance Frig.	(W A -10°C)	623	830	1037	1245	1660	2075	2490
Consumo Consumption Consommation	(kWh/ 24h)	-	-	-	-	-	-	-
Refrigerante Refrigerant Gaz		R-290						
Opcional Optional Options								

Laterales no incluidos en el precio  
Side panels not included in price  
Joues non incluses dans le prix



# VBC U

**Vitrina expositora modular frío ventilado grupo incorporado /**  
**Refrigerated modular plugin display case /**  
**Vitrine présentation froid ventilé canalisable groupe incorporé**

**Mueble caja /**  
**Counter case /**  
**Meuble de comptoir**

		CON RESERVA / WHIT STORAGE / AVEC RÉSERVE RIU: Plano Inox / Stainless Steel exhibition plan / Plan d'exposition Inox				MUEBLE CAJA / COUNTER CASE / MEUBLE DE COMPTOIR			
MODELO MODELE MODÈLE									
Precio Price Prix	RU RIU								
		SIN RESERVA / WHITOUT STORAGE / SANS RÉSERVE SIU: Plano Inox / Stainless Steel exhibition plan / Plan d'exposition Inox							
MODELO MODELE MODÈLE						-	-	-	-
Precio Price Prix	SU SIU								
Medidas Measures Mesures	(mm)	1326 x 1150 x 1290 mm.	1108 x 1150 x 1290 mm.	1887 x 1150 x 1290 mm.	1470 x 1150 x 1290 mm.	938 x 1150 x 906 mm.	1250 x 1150 x 906 mm.	1562 x 1150 x 906 mm.	1250 x 1150 x 906 mm.
Temperatura Temperature Température	(°C)	0°C/+6°C							
Clase Climática Climatic class Classe climatique	(°C)	4 / 30°C							
Tensión/Frecuencia Electrical data Tension électrique		230V/1ph/50Hz							
Controlador Controller Régulateur		Digital							
Material Matériel	[EXT/INT]	Ext: acero plastificado / Plastified stainless steel / Acier plastifié Encimera / Worktop / Dessous: Inox Aisi 304 Plano exposición / Exhibition plan / Plan d'exposition: Acero plastif./ Plastif. Stainless steel/ Acier plastifié (Mod RU/SU) - Inox Aisi 304 (Mod. RIU/SIU)							
Aislamiento Isolation Isolation		40kg/m <sup>3</sup> / Free CFC's / Zero ODP-GWP							
Capacidad Capacity Capacité	(L)	-	-	-	-	-	-	-	-
Superficie exposición Surface exhibition Surface d'exposition	(m <sup>2</sup> )	1,09	0,60	1,43	0,72	0,55	0,74	0,92	
Compresor Compressor Compresseur	(HP)	5/8	3/8	3/4	1/2	-	-	-	
Estantes Shelving Étagères		1							
Costados (2) Sides (2) Joues (2)	(mm)	30+30							
Sistema de frío Cooling System Système de froid		Ventilado / Ventilated / Ventilé							
Desescarche Defrost Dégivrage		Automático / Automatic / Automatique							
Evaporación Evaporation Évaporation		Forzada / Forced / Ventilé							
Potencia Power Puissance	(W)	1025	700	1110	780	-	-	-	-
Potencia frig. Cooling capacity Puissance Frig.	(W A -10°C)	-	-	-	-	-	-	-	-
Consumo Consumption Consommation	(kWh/ 24h)	14,4	9,8	15,5	10,9	-	-	-	-
Refrigerante Refrigerant Gaz		R-290							
Opcional Optional Options									

**Laterales no incluidos en el precio**  
**Side panels not included in price**  
**Joues non incluses dans le prix**

**Laterales incluidos en el precio**  
**Side panels included in price**  
**Joues incluses dans le prix**













# VBC

**Vitrina expositora modular frío ventilado grupo remoto /**  
**Refrigerated modular display remote case /**  
**Vitrine présentation froid ventilé canalisable groupe à distance**

**Mueble caja /**  
**Counter case /**  
**Meuble de comptoir**

**CON RESERVA / WHIT STORAGE / AVEC RÉSERVE**  
**RI: Plano Inox / Stainless Steel exhibition plan / Plan d'exposition Inox**

**MUEBLE CAJA / COUNTER CASE / MEUBLE DE COMPTOIR**

MODELO MODELE MODÈLE								
<b>Precio</b> Price Prix	<b>R</b>							
	<b>RI</b>							
<b>MODELO</b> <b>MODELE</b> <b>MODÈLE</b>	<b>SIN RESERVA / WHITOUT STORAGE / SANS RÉSERVE</b> <b>SIU: Plano Inox / Stainless Steel exhibition plan / Plan d'exposition Inox</b>							
					-	-	-	-
	<b>VBC 90 AA S/SI</b>	<b>VBC 45 AA S/SI</b>	<b>VBC 90 AC S/SI</b>	<b>VBC 45 AC S/SI</b>				
<b>Precio</b> Price Prix	<b>S</b>							
	<b>SI</b>							
<b>Medidas</b> Measures Mesures (mm)	1326 x 1150 x 1290 mm.	1108 x 1150 x 1290 mm.	1887 x 1150 x 1290 mm.	1470 x 1150 x 1290 mm.	938 x 1150 x 906 mm.	1250 x 1150 x 906 mm.	1562 x 1150 x 906 mm.	1250 x 1150 x 906 mm.
<b>Temperatura</b> Temperature Température (°C)	0°C/+6°C							
<b>Clase Climática</b> Climatic class Classe climatique (°C)	4 / 30°C							
<b>Tensión/Frecuencia</b> Electrical data Tension électrique	230V/1ph/50Hz							
<b>Controlador</b> Controller Régulateur	Digital							
<b>Material</b> Matériel (EXT/INT)	Ext: acero plastificado / Plastified stainless steel / Acier plastifié Encimera / Worktop / Dessous: Inox Aisi 304 Plano exposición / Exhibition plan / Plan d'exposition: Acero plastif./Plastif. Stainless steel/ Acier plastifié (Mod RU/SU) - Inox Aisi 304 (Mod. RIU/SIU)							
<b>Aislamiento</b> Isolation	40kg/m <sup>3</sup> / Free CFC's / Zero ODP-GWP							
<b>Capacidad</b> Capacity Capacité (L)	-	-	-	-	-	-	-	-
<b>Superficie exposición</b> Surface exhibition Surface d'exposition (m <sup>2</sup> )	1,09	0,60	1,43	0,72	0,55	0,74	0,92	
<b>Compresor</b> Compressor Compresseur (HP)	-	-	-	-	-	-	-	-
<b>Estantes</b> Shelving Étagères	1							
<b>Costados [2]</b> Sides [2] Joues [2] (mm)	30+30							
<b>Sistema de frío</b> Cooling System Système de froid	Ventilado / Ventilated / Ventilé							
<b>Desescarche</b> Defrost Dégivrage	Automático / Automatic / Automatique							
<b>Evaporación</b> Evaporation Évaporation	Forzada / Forced / Ventilé							
<b>Potencia</b> Power Puissance (W)	-	-	-	-	-	-	-	-
<b>Potencia frig.</b> Cooling capacity Puissance Frig. (W A -10°C)	304	403	11598	801	-	-	-	-
<b>Consumo</b> Consumption Consommation (kWh/24h)	-	-	-	-	-	-	-	-
<b>Refrigerante</b> Refrigerant Gaz	<b>R-290</b>							
<b>Opcional</b> Optional Options								

**Laterales no incluidos en el precio**  
**Side panels not included in price**  
**Joues non incluses dans le prix**

**Laterales incluidos en el precio**  
**Side panels included in price**  
**Joues incluses dans le prix**



# VBC CP

**Vitrina expositora modular frío ventilado /**  
**Refrigerated modular display case /**  
**Vitrine présentation froid ventilé canalisable**

## CARACTERÍSTICAS

Vitrina remota/grupo incorporado (U), con reserva (R)/sin reserva (S), de cristal recto para servicio asistido.  
 Diseñada para carnes y alimentos precocinados ya envasados, charcutería, lácteos y sándwiches.  
 Sistema de refrigeración ventilado.  
 Reserva refrigerada para multiplicar las opciones del servicio de venta (R).  
 Encimera de trabajo ergonómica en acero inoxidable AISI304.  
 Estante intermedio de cristal templado.  
 Encimera superior de cristal templado.  
 Exposición en acero inox. AISI304 (I).  
 Decoración chapa lacada según carta de colores.  
 Vidrios frontales elevables.  
 Estructura y soporte de cristales en perfilera de aluminio anodizado.  
 Equipamiento de alta eficiencia:  
 - Iluminación doble LED color carne en exposición.  
 - Iluminación LED decorativa blanco frío 6000K.  
 - Ventiladores electrónicos.

## MAIN FEATURES

Remote display case/plug in (U), with storage (R)/without storage (S), straight glass for assisted service.  
 Designed for pre-packed meats and convenience foods, deli, dairy and sandwiches.  
 Ventilated refrigeration system.  
 Refrigerated reserve to multiply vending options (R).  
 Ergonomic worktop in AISI304 stainless steel.  
 Intermediate shelf in tempered glass.  
 Upper worktop in tempered glass.  
 Stainless steel display. AISI304 (I).  
 Lacquered steel plate decoration according to colour chart.  
 Flip-up front glass.  
 Structure and glass support in anodised aluminium profiles.  
 High efficiency equipment:  
 - Double meat-coloured LED lighting on display.  
 - 6000K cool white decorative LED lighting.  
 - Electronic fans.

## CARACTERISTIQUES

Vitrine à distance/groupe incorporé (U), avec réserve (R)/sans réserve (S), verre droit pour service assisté.  
 Conçu pour les viandes préemballées et les plats cuisinés, la charcuterie, les produits laitiers et les sandwiches.  
 Système de réfrigération ventilé.  
 Réserve réfrigérée pour multiplier les possibilités de distribution (R).  
 Plan de travail ergonomique en acier inoxydable AISI304.  
 Étagère intermédiaire en verre trempé.  
 Plan de travail supérieur en verre trempé.  
 Présentoir en acier inoxydable AISI304 (I).  
 Décoration en acier laqué selon le nuancier.  
 Verre frontal relevable.  
 Structure et support du verre en profilés d'aluminium anodisé.  
 Équipement à haut rendement :  
 - Double éclairage LED couleur chair sur le présentoir.  
 - Éclairage décoratif à LED blanc froid 6000K.  
 - Ventilateurs électroniques.



VBC 37 RUCP

Serie / Series / Série

**VBC CP**  
**BARCELONA**

**RU/RIU/SU/SIU: Grupo Incorporado / Plug in / Groupe incorporé**  
**R/R/S/SI: Grupo Remoto / Remote / Groupe à distance**



**CON RESERVA / WHIT STORAGE / AVEC RÉSERVE - RIU/RI: Plano Inox / Stainless Steel exhibition plan / Plan d'exposition Inox**

**VBC 9 RUCP/RIUCP VBC 12 RUCP/RIUCP VBC 15 RUCP/RIUCP VBC 18 RUCP/RIUCP VBC 25 RUCP/RIUCP VBC 31 RUCP/RIUCP VBC 37 RUCP/RIUCP**  
**VBC 9 RCP/RICP VBC 12 RCP/RICP VBC 15 RCP/RICP VBC 18 RCP/RICP VBC 25 RCP/RICP VBC 31 RCP/RICP VBC 37 RCP/RICP**

**SIN RESERVA / WHITOUT STORAGE / SANS RÉSERVE - SIU/SI: Plano Inox / Stainless Steel exhibition plan / Plan d'exposition Inox**

**VBC 9 SUCP/SIUCP VBC 12 SUCP/SIUCP VBC 15 SUCP/SIUCP VBC 18 SUCP/SIUCP VBC 25 SUCP/SIUCP VBC 31 SUCP/SIUCP VBC 37 SUCP/SIUCP**  
**VBC 9 SCP/SICP VBC 12 SCP/SICP VBC 15 SCP/SICP VBC 18 SCP/SICP VBC 25 SCP/SICP VBC 31 SCP/SICP VBC 37 SCP/SICP**



**CON RESERVA / WHIT STORAGE / AVEC RÉSERVE**  
**RIU: Plano Inox / Stainless Steel exhibition plan / Plan d'exposition Inox**  
**VBC90 A RUCP/RIUCP VBC90 C RUCP/RIUCP**  
**VBC90 AARRCP/AIRRCPI VBC90 ACRRCP/CRRCPPI**

**SIN RESERVA / WHITOUT STORAGE / SANS RÉSERVE**  
**SIU: Plano Inox / Stainless Steel exhibition plan / Plan d'exposition Inox**  
**VBC90 A SUCP/SIUCP VBC90 C SUCP/SIUCP**  
**VBC90 AARSCP/ARISCP VBC90 ACRSCP/CRSCPI**

**MUEBLE CAJA / COUNTER CASE / MEUBLE DE COMPTOIR**

**VBC 9 CP VBC 12 MP VBC 15 MP VBC 12 MHPD**

# Modelos

Serie/Series/Série **VBC CP BARCELONA**



VBC 15 SUCP

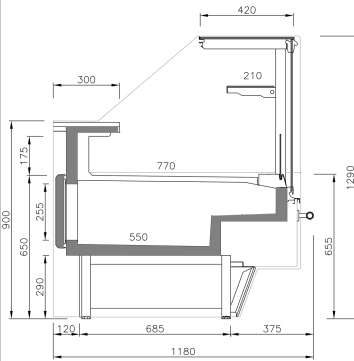

VBC RU **[con reserva]**  
[Whit storage]  
[Avec réserve]

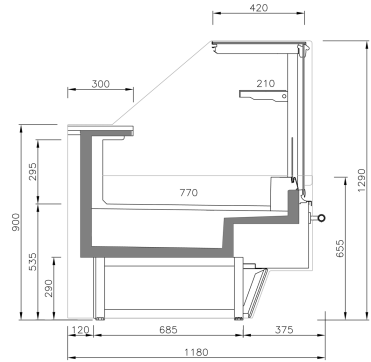

VBC SU **[Sin reserva]**  
[Whitout storage]  
[Sans réserve]

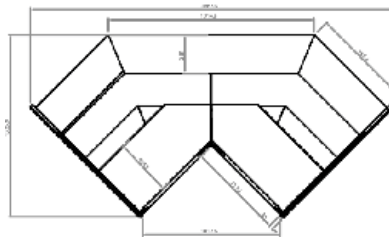

VBC 90 AC RUCP/SUCP

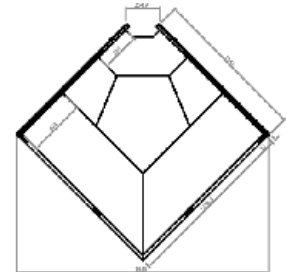

VBC 90 AA RUCP/SUCP



ÁNGULOS / ANGLES / ANGLES VCB CP

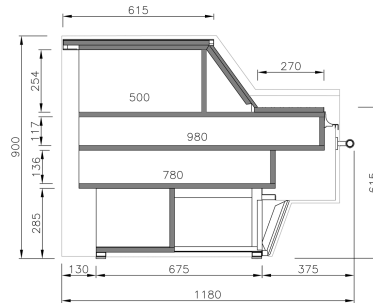

VBC C/M



VBC12M

**Colores fuera de carta /**  
Colors outside of letter /  
Couleurs spéciales, hors palette

RAL		NO RAL	
Epoxi	Líquida/ Liquid/ Liquide	Epoxi	Líquida/ Liquid/ Liquide
[x unidad/x unit/x unité]		Consultar / Consultar / Consultar	
+10 días laborables / +10 work days / +10 jours ouvrés		Consultar / Consultar / Consultar	

**Laterales / Sides / Jous**

NO	
Izquierdo Left Gauche	Derecho Right Droite

**Int. Estándar / Standar / Standard**

Blanco/White/ Blanc	Negro/Black/ Noir	Ral 7016	INOX (I)
------------------------	----------------------	----------	----------

**Ext. Estándar / Standar / Standard**

Blanco/White/ Blanc	Ral 1015	Ral 1018	Ral 2003	Ral 3003	Ral 3020	Ral 5015
Ral 5017	Ral 5011	Ral 6002	Ral 6018	Ral 6019	Ral 7035	Ral 7037
Ral 7042	Ral 7016	Ral 9006	Ral 7013	Negro/Black/ Noir	Roble natural	



# VBC UCP

Vitrina expositora modular frío ventilado grupo incorporado /  
Refrigerated modular plugin display case /  
Vitrine présentation froid ventilé canalisable groupe incorporé

CON RESERVA / WHIT STORAGE / AVEC RÉSERVE - RIU: Plano Inox / Stainless Steel exhibition plan / Plan d'exposition Inox

MODELO  
MODELE  
MODÈLE



Precio Price Prix	RUCP RIUCP							
-------------------------	---------------	--	--	--	--	--	--	--

SIN RESERVA / WHITOUT STORAGE / SANS RÉSERVE - SIU: Plano Inox / Stainless Steel exhibition plan / Plan d'exposition Inox

MODELO  
MODELE  
MODÈLE



Precio Price Prix	SUCP SIUCP							
-------------------------	---------------	--	--	--	--	--	--	--

Medidas Measures Mesures	[mm]	938 x 1150 x 1290 mm.	1250 x 1150 x 1290 mm.	1562 x 1150 x 1290 mm.	1875 x 1150 x 1290 mm.	2500 x 1150 x 1290 mm.	3125 x 1150 x 1290 mm.	3750 x 1150 x 1290 mm.
Temperatura Temperature Température	[°C]	0°C/+6°C						
Clase Climática Climatic class Classe climatique	[°C]	4 / 30°C						
Tensión/Frecuencia Electrical data Tension électrique		230V/1ph/50Hz						
Controlador Controller Régulateur		Digital						
Material Matériel	[EXT/INT]	Ext: acero plastificado / Plastified stainless steel / Acier plastifié Encimera / Worktop / Dessous: Inox Aisi 304 Plano exposición / Exhibition plan / Plan d'exposition: Acero plastif./ Plastif. Stainless steel/ Acier plastifié [Mod RU/SU] - Inox Aisi 304 [Mod. RIU/SIU]						
Aislamiento Isolation Isolation		40kg/m <sup>3</sup> / Free CFC's / Zero ODP-GWP						
Capacidad Capacity Capacité	[L]	82	109	137	164	219	273	328
Superficie exposición Surface exhibition Surface d'exposition	[m <sup>2</sup> ]	0,92	1,23	1,53	1,84	2,45	3,06	3,68
Compresor Compressor Compresseur	[HP]	1/3	1/2	3/4	3/4	1+1/4	1+1/4	1+1/4
Estantes Shelving Étagères		1						
Costados (2) Sides (2) Joues (2)	[mm]	30+30						
Sistema de frío Cooling System Système de froid		Ventilado / Ventilated / Ventilé						
Desescarche Defrost Dégivrage		Automático / Automatic / Automatique						
Evaporación Evaporation Évaporation		Forzada / Forced / Ventilé						
Potencia Power Puissance	[W]	374	532	601	702	1177	1210	1234
Potencia frig. Cooling capacity Puissance Frig.	[W A -10°C]	-	-	-	-	-	-	-
Consumo Consumption Consommation	[kWh/ 24h]	4.7	6.4	7.2	8.4	12.7	14.5	16.3
Refrigerante Refrigerant Gaz		R-290						
Opcional Optional Options								















Laterales no incluidos en el precio  
Side panels not included in price  
Joues non incluses dans le prix



# VBC CP

**Vitrina expositora modular frío ventilado grupo remoto /**  
**Refrigerated modular display remote case /**  
**Vitrine présentation froid ventilé canalisable groupe à distance**

**CON RESERVA / WHIT STORAGE / AVEC RÉSERVE - RI: Plano Inox / Stainless Steel exhibition plan / Plan d'exposition Inox**

MODELO MODELE MODÈLE							
Precio Price Prix	RCP	RCP	RCP	RCP	RCP	RCP	RCP
MODELO MODELE MODÈLE							
Precio Price Prix	SCP	SCP	SCP	SCP	SCP	SCP	SCP
<b>Medidas</b> Measures Mesures	[mm] 938 x 1150 x 1290 mm.	1250 x 1150 x 1290 mm.	1562 x 1150 x 1290 mm.	1875 x 1150 x 1290 mm.	2500 x 1150 x 1290 mm.	3125 x 1150 x 1290 mm.	3750 x 1150 x 1290 mm.
<b>Temperatura</b> Temperature Température	[°C] 0°C/+6°C						
<b>Clase Climática</b> Climatic class Classe climatique	[°C] 4 / 30°C						
<b>Tensión/Frecuencia</b> Electrical data Tension électrique	230V/1ph/50Hz						
<b>Controlador</b> Controller Régulateur	Digital						
<b>Material</b> Material Matériel	[EXT/INT] Ext: acero plastificado / Plastified stainless steel / Acier plastifié Encimera / Worktop / Dessous: Inox Aisi 304 Plano exposición / Exhibition plan / Plan d'exposition: Acero plastif./Plastif. Stainless steel/ Acier plastifié (Mod R/S) - Inox Aisi 304 (Mod. S/SI)						
<b>Aislamiento</b> Isolation	40kg/m <sup>3</sup> / Free CFC's / Zero ODP-GWP						
<b>Capacidad</b> Capacity Capacité	[L] 82	109	137	164	219	273	328
<b>Superficie exposición</b> Surface exhibition Surface d'exposition	[m <sup>2</sup> ] 0,92	1,23	1,53	1,84	2,45	3,06	3,68
<b>Compresor</b> Compressor Compresseur	[HP] -	-	-	-	-	-	-
<b>Estantes</b> Shelving Étagères	1						
<b>Costados [2]</b> Sides [2] Joues [2]	[mm] 30+30						
<b>Sistema de frío</b> Cooling System Système de froid	Ventilado / Ventilated / Ventilé						
<b>Desescarche</b> Defrost Dégivrage	Automático / Automatic / Automatique						
<b>Evaporación</b> Evaporation Évaporation	Forzada / Forced / Ventilé						
<b>Potencia</b> Power Puissance	[W] -	-	-	-	-	-	-
<b>Potencia frig.</b> Cooling capacity Puissance Frig.	[W A -10°C] 656	874	1092	1315	1748	2184	2621
<b>Consumo</b> Consumption Consommation	[kWh/ 24h] -	-	-	-	-	-	-
<b>Refrigerante</b> Refrigerant Gaz	R-290						
<b>Opcional</b> Optional Options							









**Laterales no incluidos en el precio**  
**Side panels not included in price**  
**Joues non incluses dans le prix**



# VBC UCP

Vitrina expositora modular frío ventilado grupo incorporado /  
Refrigerated modular plugin display case /  
Vitrine présentation froid ventilé canalisable groupe incorporé

Mueble caja /  
Counter case /  
Meuble de comptoir

		CON RESERVA / WHIT STORAGE / AVEC RÉSERVE RIU: Plano Inox / Stainless Steel exhibition plan / Plan d'exposition Inox		MUEBLE CAJA / COUNTER CASE / MEUBLE DE COMPTOIR			
							
MODELO MODELE MODÈLE		VBC90 A RUCP/RIUCP	VBC90 C RUCP/RIUCP	VBC 9 CP	VBC 12 MP	VBC 15 MP	VBC 12 MHDP
Precio Price Prix	RUCP RIUCP						
MODELO MODELE MODÈLE	SIN RESERVA / WHITOUT STORAGE / SANS RÉSERVE SIU: Plano Inox / Stainless Steel exhibition plan / Plan d'exposition Inox			-	-	-	-
Precio Price Prix	SUCP SIUCP			-	-	-	-
Medidas Measures Mesures	[mm]	1887 x 1150 x 1290 mm.	1470 x 1150 x 1290 mm.	938 x 1150 x 906 mm.	1250 x 1150 x 906 mm.	1562 x 1150 x 906 mm.	1250 x 1150 x 906 mm.
Temperatura Temperature Température	[°C]	0°C/+6°C					
Clase Climática Climatic class Classe climatique	[°C]	4 / 30°C					
Tensión/Frecuencia Electrical data Tension électrique		230V/1ph/50Hz					
Controlador Controller Régulateur		Digital					
Material Matériel	[EXT/INT]	Ext: acero plastificado / Plastified stainless steel / Acier plastifié Encimera / Worktop / Dessous: Inox Aisi 304 Plano exposición / Exhibition plan / Plan d'exposition: Acero plastif./ Plastif. Stainless steel/ Acier plastifié (Mod RU/SU) - Inox Aisi 304 (Mod. RIU/SIU)					
Aislamiento Isolation Isolation		40kg/m <sup>3</sup> / Free CFC's / Zero ODP-GWP					
Capacidad Capacity Capacité	[L]	1,09	1,43	-	-	-	-
Superficie exposición Surface exhibition Surface d'exposition	[m <sup>2</sup> ]	-	-	0,55	0,74	0,92	-
Compresor Compressor Compresseur	[HP]	5/8	3/4	-	-	-	-
Estantes Shelving Étagères		-					
Costados (2) Sides (2) Joues (2)	[mm]	30+30					
Sistema de frío Cooling System Système de froid		Ventilado / Ventilated / Ventilé					
Desescarche Defrost Dégivrage		Automático / Automatic / Automatique					
Evaporación Evaporation Évaporation		Forzada / Forced / Ventilé					
Potencia Power Puissance	[W]	1025	1110	-	-	-	-
Potencia frig. Cooling capacity Puissance Frig.	[W A -10°C]	-	-	-	-	-	-
Consumo Consumption Consommation	[kWh/ 24h]	14,4	15,5	-	-	-	-
Refrigerante Refrigerant Gaz		R-290					
Opcional Optional Options		-					

Laterales no incluidos en el precio  
Side panels not included in price  
Joues non incluses dans le prix









Laterales incluidos en el precio  
Side panels included in price  
Joues incluses dans le prix



# VBC CP

**Vitrina expositora modular frío ventilado grupo remoto /**  
**Refrigerated modular display remote case /**  
**Vitrine présentation froid ventilé canalisable groupe à distance**

**Mueble caja /**  
**Counter case /**  
**Meuble de comptoir**

		CON RESERVA / WHIT STORAGE / AVEC RÉSERVE Rt: Plano Inox / Stainless Steel exhibition plan / Plan d'exposition Inox		MUEBLE CAJA / COUNTER CASE / MEUBLE DE COMPTOIR			
MODELO MODELE MODÈLE							
Precio Price Prix	RCP IRCP						
MODELO MODELE MODÈLE		SIN RESERVA / WHITOUT STORAGE / SANS RÉSERVE St: Plano Inox / Stainless Steel exhibition plan / Plan d'exposition Inox					
				-	-	-	-
Precio Price Prix	SCP ISCP						
Medidas Measures Mesures	(mm)	1887 x 1150 x 1290 mm.	1470 x 1150 x 1290 mm.	938 x 1150 x 906 mm.	1250 x 1150 x 906 mm.	1562 x 1150 x 906 mm.	1250 x 1150 x 906 mm.
Temperatura Temperature Température	[°C]	0°C/+6°C					
Clase Climática Climatic class Classe climatique	[°C]	4 / 30°C					
Tensión/Frecuencia Electrical data Tension électrique		230V/1ph/50Hz					
Controlador Controller Régulateur		Digital					
Material Material Matériel	[EXT/INT]	Ext: acero plastificado / Plastified stainless steel / Acier plastifié Encimera / Worktop / Dessous: Inox Aisi 304 Plano exposición / Exhibition plan / Plan d'exposition: Acero plastif./Plastif. Stainless steel/ Acier plastifié (Mod RCP/SCP) - Inox Aisi 304 (Mod. I)					
Aislamiento Isolation Isolation		40kg/m <sup>3</sup> / Free CFC's / Zero ODP-GWP					
Capacidad Capacity Capacité	(L)	1,09	1,43	-	-	-	-
Superficie exposición Surface exhibition Surface d'exposition	(m <sup>2</sup> )	-	-	0,55	0,74	0,92	-
Compresor Compressor Compresseur	(HP)	-	-	-	-	-	-
Estantes Shelving Étagères		-					
Costados [2] Sides [2] Joues [2]	(mm)	30+30					
Sistema de frío Cooling System Système de froid		Ventilado / Ventilated / Ventilé					
Desescarche Defrost Dégivrage		Automático / Automatic / Automatique					
Evaporación Evaporation Évaporation		Forzada / Forced / Ventilé					
Potencia Power Puissance	(W)	-	-	-	-	-	-
Potencia frig. Cooling capacity Puissance Frig.	[W A -10°C]	1096	1315	-	-	-	-
Consumo Consumption Consommation	(kWh/ 24h)	-	-	-	-	-	-
Refrigerante Refrigerant Gaz		R-290					
Opcional Optional Options							

**Laterales no incluidos en el precio**  
**Side panels not included in price**  
**Joues non incluses dans le prix**

**Laterales incluidos en el precio**  
**Side panels included in price**  
**Joues incluses dans le prix**



# VBC CB

**Vitrina remota (S) cristal bajo recto sin reserva / grupo incorporado (U)**

**Remote (S) display counter straight low glass without storage / plug in (U)**

**Vitrine group à distance (S) verre bas droit sans réserve / groupe incorporé (U)**

## CARACTERÍSTICAS

Vitrina remota/grupo incorporado (U) de cristal bajo recto para autoservicio.  
Diseñada para alimentos precocinados ya envasados, charcutería, lácteos y sándwiches.  
Sistema de refrigeración ventilado.  
Cristales templados.  
Encimera de trabajo ergonómica en acero inoxidable AISI304.  
Exposición en acero inox. AISI304 (I).  
Decoración en chapa lacada según carta de colores.  
Apertura de cristales abatible.  
Equipamiento de alta eficiencia:  
- Iluminación LED decorativa.  
- Ventiladores electrónicos.  
Modelo engamable con VBCCP.

## MAIN FEATURES

Remote display case/plug in (U) straight low glass for self-service.  
Designed for pre-packed convenience foods, deli, dairy and sandwiches.  
Ventilated refrigeration system.  
Tempered glass.  
Ergonomic worktop in AISI304 stainless steel.  
Stainless steel display. AISI304 (I).  
Decoration in lacquered veneer according to colour chart.  
Folding glass opening.  
High efficiency equipment:  
- Decorative LED lighting.  
- Low consumption.  
Model can be combined with the VBCCP range.

## CARACTERISTIQUES

Vitrine à distance/groupe incorporé (U) verre bas droit pour self-service.  
Conçu pour les plats préparés préemballés, la charcuterie, les produits laitiers et les sandwiches.  
Système de réfrigération ventilé.  
Verre trempé.  
Plan de travail ergonomique en acier inoxydable AISI304.  
Présentoir en acier inoxydable AISI304 (I).  
Décoration en placage laqué selon nuancier.  
Ouverture de la vitre pliable.  
Équipement à haut rendement :  
- Éclairage décoratif à LED.  
- Ventilateurs électroniques.  
Modèle combinable avec la gamme VBCCP.



VBC 37 SU CB

Serie / Series / Série

**VBC CB  
BARCELONA**



**VBC 9 SCB / SICB  
VBC 9 SUCB / SIUCB**



**VBC 12 SCB / SICB  
VBC 12 SUCB / SIUCB**



**VBC 15 SCB / SICB  
VBC 15 SUCB / SIUCB**



**VBC 18 SCB / SICB  
VBC 18 SUCB / SIUCB**



**VBC 25 SCB / SICB  
VBC 25 SUCB / SIUCB**

**S/SI: Grupo Remoto / Remote / Groupe à distance  
SU/SIU: Grupo Incorporado / Plug in / Groupe incorporé  
SI/SIU: Plano Inox / Stainless Steel exhibition plan / Plan d'exposition Inox**

# Modelos

Serie/Series/Série **VBC CB BARCELONA**

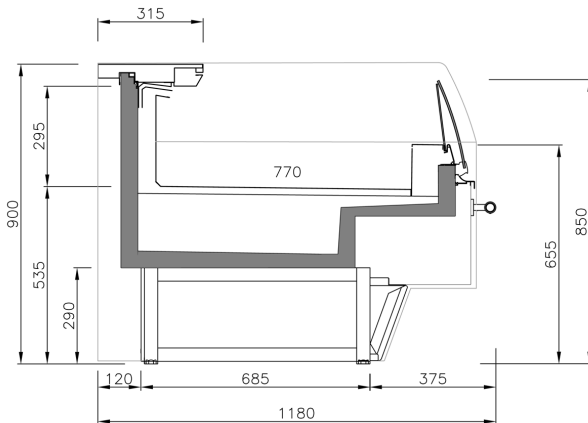

VBC SUCB



VBC SUCB



Cortina nocturna de serie  
Standard night curtain  
Rideau de nuit de série

**Colores fuera de carta /**  
Colors outside of letter /  
Couleurs spéciales, hors palette

RAL		NO RAL	
Epoxi	Líquida/ Liquid/ Liquide	Epoxi	Líquida/ Liquid/ Liquide
<b>833 €</b>	<b>518 €</b>	Consultar / Consultar / Consultar	
[x unidad/x unit/x unité]			
+10 días laborables / +10 work days / +10 jours ouvrés		Consultar / Consultar / Consultar	

**Laterales / Sides / Joues**

NO	
Izquierdo Left Gauche	Derecho Right Droite
<b>339 €</b>	<b>339 €</b>

**Int. Estándar / Standar / Standard**

Blanco/White/ Blanc	Negro/Black/ Noir	Ral 7016	INOX (I)
------------------------	----------------------	----------	----------





**Ext. Estándar / Standar / Standard**

Blanco/White/ Blanc	Ral 1015	Ral 1018	Ral 2003	Ral 3003	Ral 3020	Ral 5015
Ral 5017	Ral 5011	Ral 6002	Ral 6018	Ral 6019	Ral 7035	Ral 7037
Ral 7042	Ral 7016	Ral 9006	Ral 7013	Negro/Black/ Noir	Roble natural	

# VBC UCB

Vitrina expositora modular frío ventilado grupo incorporado /  
Refrigerated modular plugin display case /  
Vitrine présentation froid ventilé canalisable groupe incorporé

SIU: Plano Inox / Stainless Steel exhibition plan / Plan d'exposition Inox





MODELO MODELE MODÈLE						
	SUCB SIUCB	VBC 9 SUCB / SIUCB	VBC 12 SUCB / SIUCB	VBC 15 SUCB / SIUCB	VBC 18 SUCB / SIUCB	VBC 25 SUCB / SIUCB
Precio Price Prix						
Medidas Measures Mesures	[mm]	938 x 1181 x 897 mm.	1250 x 1181 x 897 mm.	1562 x 1181 x 897 mm.	1875 x 1181 x 897 mm.	2500 x 1181 x 897 mm.
Temperatura Temperature Température	[°C]	0°C/+6°C				
Clase Climática Climatic class Classe climatique	[°C]	4 / 30°C				
Tensión/Frecuencia Electrical data Tension électrique		230V/1ph/50Hz				
Controlador Controller Régulateur		Digital				
Material Matériel	[EXT/INT]	Ext: acero plastificado / Plastified stainless steel / Acier plastifié Encimera / Worktop / Dessous: Inox Aisi 304 Plano exposición / Exhibition plan / Plan d'exposition: Acero plastif./ Plastif. Stainless steel/ Acier plastifié (Mod SUCB/SUCP) - Inox Aisi 304 (Mod. I)				
Aislamiento Isolation Isolation		40kg/m <sup>3</sup> / Free CFC's / Zero ODP-GWP				
Capacidad Capacity Capacité	[L]	108	144	180	217	289
Superficie exposición Surface exhibition Surface d'exposition	[m <sup>2</sup> ]	0,72	0,96	1,20	1,44	1,93
Compresor Compressor Compresseur	[HP]	1/3	1/2	3/4	3/4	1+1/4
Estantes Shelving Étagères		-				
Costados [2] Sides [2] Joues [2]	[mm]	30+30				
Sistema de frío Cooling System Système de froid		Ventilado / Ventilated / Ventilé				
Desescarche Defrost Dégivrage		Automático / Automatic / Automatique				
Evaporación Evaporation Évaporation		Forzada / Forced / Ventilé				
Potencia Power Puissance	[W]	593	701	816	823	1207
Potencia frig. Cooling capacity Puissance Frig.	[W A -10°C]	-	-	-	-	-
Consumo Consumption Consommation	[kWh/ 24h]	7,10	8,04	9,80	10,1	14,5
Refrigerante Refrigerant Gaz		R-290				
Opcional Optional Options		-				

Laterales no incluidos en el precio  
Side panels not included in price  
Joues non incluses dans le prix

# VBC CB

**Vitrina expositora modular frío ventilado grupo remoto /**  
**Refrigerated modular display remote case /**  
**Vitrine présentation froid ventilé canalisable groupe à distance**

SI: Plano Inox / Stainless Steel exhibition plan / Plan d'exposition Inox

MODELO MODELE MODÈLE					
	VBC 9 SCB / SICB	VBC 12 SCB / SICB	VBC 15 SCB / SICB	VBC 18 SCB / SICB	VBC 25 SCB / SICB
<b>Precio</b> Price Prix	<b>SCB</b>				
	<b>SICB</b>				
<b>Medidas</b> Measures Mesures	(mm) 938 x 1181 x 897 mm.	1250 x 1181 x 897 mm.	1562 x 1181 x 897 mm.	1875 x 1181 x 897 mm.	2500 x 1181 x 897 mm.
<b>Temperatura</b> Temperature Température	[°C] <b>0°C/+6°C</b>				
<b>Clase Climática</b> Climatic class Classe climatique	[°C] 4 / 30°C				
<b>Tensión/Frecuencia</b> Electrical data Tension électrique	230V/1ph/50Hz				
<b>Controlador</b> Controller Régulateur	Digital				
<b>Material</b> Matériel	[EXT/INT] Ext: acero plastificado / Plastified stainless steel / Acier plastifié Encimera / Worktop / Dessous: Inox Aisi 304 Plano exposición / Exhibition plan / Plan d'exposition: Acero plastif./ Plastif. Stainless steel/ Acier plastifié (Mod SCB/SCP) - Inox Aisi 304 (Mod. I)				
<b>Aislamiento</b> Isolation Isolation	40kg/m <sup>3</sup> / Free CFC's / Zero ODP-GWP				
<b>Capacidad</b> Capacity Capacité	[L] 108	144	180	217	289
<b>Superficie exposición</b> Surface exhibition Surface d'exposition	[m <sup>2</sup> ] 0,72	0,96	1,20	1,44	1,93
<b>Compresor</b> Compressor Compresseur	[HP] -	-	-	-	-
<b>Estantes</b> Shelving Étagères	-				
<b>Costados [2]</b> Sides [2] Joues [2]	[mm] 30+30				
<b>Sistema de frío</b> Cooling System Système de froid	Ventilado / Ventilated / Ventilé				
<b>Desescarche</b> Defrost Dégivrage	Automático / Automatic / Automatique				
<b>Evaporación</b> Evaporation Évaporation	Forzada / Forced / Ventilé				
<b>Potencia</b> Power Puissance	[W] -	-	-	-	-
<b>Potencia frig.</b> Cooling capacity Puissance Frig.	[W A -10°C] 817	1096	1315	1506	2009
<b>Consumo</b> Consumption Consommation	[kWh/ 24h] -	-	-	-	-
<b>Refrigerante</b> Refrigerant Gaz	<b>R-290</b>				
<b>Opcional</b> Optional Options	-				

**Laterales no incluidos en el precio**  
**Side panels not included in price**  
**Joues non incluses dans le prix**

