

9. Supermarket



Barcelona - Spain

Waterin



254-257

Serie / Series / Série

VMD Madrid



VMD RU/SU
VMD R/S
VMD C / M 258-263

Serie / Series / Série

VBC Barcelona



VBC R/RU / S/SU
VBC C / M / MHD
VBC R/RU CP / S/SU CP
VBC CP / MP / MHDP
VBC S CB/SU CB 264-279

Serie / Series / Série

VEX Experience



VEX CP
VEX
VEX CB
VEX CA / CP HT
VEX HT7GC/GF 280-291

Serie / Series / Série

VEE California



VEE
VEE CA
VEE HT
VEE GC
VEE S
VEE AAM 292-297

Serie / Series / Série

VCT Compact



VCT CP
VCT CB
VCT HT/GC 298-307

Serie / Series / Série

SVT Compact



SVT R14
SVT R
SVT HT 308-317

Serie / Series / Série

VCL Colombia



VCL CP 318-323

Serie / Series / Série

VVS/VVL Visión/Valencia



VVS
VVL 324-325

Serie / Series / Série

VPG Biggie



VPG37 326-327

Serie / Series / Série

GD/COMBI



GD P
AS25U 328-331

8. Supermarket

Estructura de cristales de alta transparencia, rectos o curvos según modelo.

High transparency glass structure, flat or curved depending on the model.

Structure en verre à haute transparence, droite ou bombée selon le modèle.

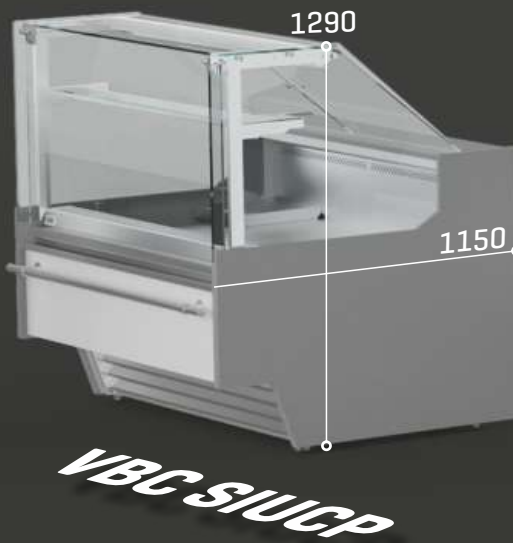
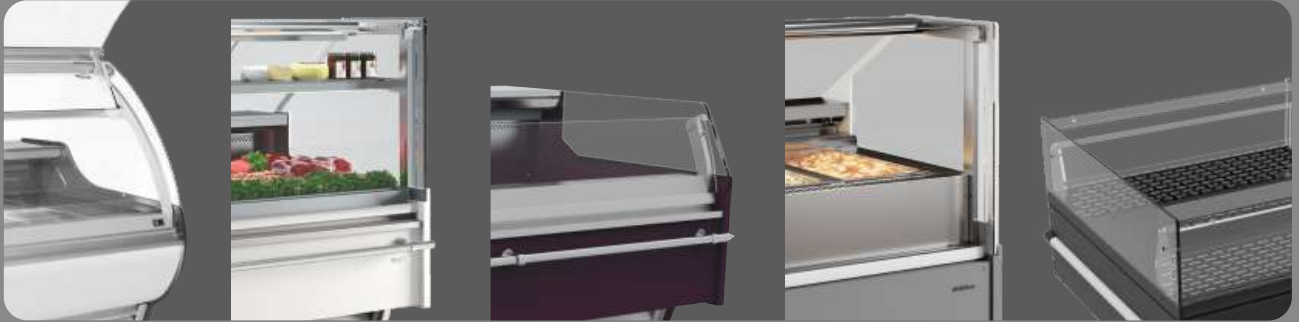

Iluminación / Lighting / Éclairage

Incorporación de iluminación LED, llegando a reducir el consumo energético entre un 80% y 90%, respecto a una bombilla tradicional.

LED lighting incorporated, reducing energetic consumption between 80% and 90% respect to a traditional light bulb.

Éclairage LED, réduisant la consommation énergétique entre 80% et 90%, par rapport à une ampoule traditionnelle.



Equipos con posibilidad de grupo remoto y grupo incorporado.

Devices with the possibility of remote group and integrated group.

Équipement avec la possibilité de groupe à distance et de groupe incorporé.



VIE CA

VVS

Máxima visibilidad de producto expuesto.

Maximum visibility of displayed product.

Visibilité maximale du produit exposé.



Amplia gama de opciones y posibilidades de personalización para exponer todo tipo de productos refrigerados sin envasar: carne, charcutería y delicatessen.

Wide range of options and customisation possibilities for displaying all types of unpackaged refrigerated products: meat, deli and delicatessen.

Nombreuses options et possibilités de personnalisation pour présenter tous les types de produits réfrigérés non emballés : viande, charcuterie et delicatessen.



Waterin

Sistema Waterloop R290 de Infrico

hasta
-25%

Sistema eficiente, hasta el 25% de ahorro de energía.
Efficient system with up to 25% energy saving.
Système efficace avec jusqu'à 25 % d'économies d'énergie.

-75%

75% reducción carga refrigerante.
75% refrigerant charge reduction.
Réduction de 75 % de la charge de réfrigérant.

0€

Refrigerantes naturales
SIN TASA.
Natural refrigerants WITHOUT CHARGE.
Réfrigérateurs naturels
SANS TÂCHE.



Mínima carga refrigerante, aprox. 0.1kg/kw.
Minimum refrigerant load, aprox. 0.1kg/kw.
Charge minimale de réfrigérant, avec environ 0,1 Kg/kw de réfrigération.



Flexibilidad de implantación.
Flexibility of implementation.
Flexibilité de mise en oeuvre.



Posibilidad de recuperación de calor en la instalación.
Possibility of heat recovery in the installation.
Possibilité de récupération de chaleur dans l'installation.



Condensadores sin mantenimiento.
Maintenance-free condensers.
Condensateurs de maintenance.



Posible eliminación de la sala de máquinas.
Possible elimination of the machine room.
Élimination possible, dans de nombreux cas, de la salle des machines.



Eliminación de riesgos típicos de inst. centralizadas.
Elimination of the typical risks of central installations.
Élimination des risques typiques des installations centralisées.



Menor riesgo de fugas.
Reduced risk of leakage.
Moins de risques de fuites.



El ahorro energético y el cuidado del medio ambiente son dos factores claves que han impulsado la iniciativa Waterin.

¿Qué es Waterin?

Waterin son muebles de refrigeración comercial para la conservación de productos refrigerados y congelados, con unidades individuales R290 y sistema de condensación por agua.

¿Dónde podemos instalar este sistema?

Este sistema es óptimo para instalaciones que cumplan los siguientes condicionantes:

- Sala de ventas de hasta 1400m² con aproximadamente hasta 40kW frigoríficos.
- Temperatura de trabajo exterior (DryCooler) máxima de 48°C.

¿Este nuevo sistema requiere un proyecto de instalación?

El sistema Waterin no requiere instalación frigorífica porque son muebles con la unidad ya instalada y cargada desde fábrica, aunque su implantación requiere un cálculo de instalación para el dimensionado de las tuberías de agua, el DryCooler, el sistema hidráulico necesarios y su ubicación, etc.

Beneficios del sistema Waterin

Waterin por ser un sistema ecológico y de condensación por agua ofrece múltiples beneficios en la refrigeración comercial. Mayor eficiencia energética, menor impacto ambiental y mejor control de temperatura son sólo algunas de sus ventajas.



Saving energy and respect for the environment are two key factors that have driven the Waterin initiative.

What's Waterin?

Waterin are commercial refrigeration display cases for the preservation of refrigerated and frozen products, with individual R290 units and water condensation system.

Where do we install this system?

This system is ideal for installations that meet the following conditions:

- Supermarkets up to 1400m² with approximately up to 40kW of refrigeration capacity.
- Outdoor working temperature (DryCooler) max. 48°C.

Is an installation project required?

The Waterin system doesn't require refrigeration installation because it's display cases with the unit already installed and loaded from the factory, although its implementation requires an installation calculation for the dimensioning of the water pipes, the DryCooler, the necessary hydraulic system and its location, etc.

Benefits of Waterin

Waterin is an environmentally friendly, water condensing system that offers multiple benefits in commercial refrigeration. Greater energy efficiency, lower environmental impact and better temperature control are just some of its advantages.



Les économies d'énergie et le respect de l'environnement sont deux facteurs qui ont motivé l'initiative Waterin.

Qu'est-ce que Waterin?

Waterin est une armoire de réfrigération commerciale pour les températures positives et négatives de stockage des produits, avec des unités R290 individuelles et un système de condensation à l'eau.

Où peut-on installer ce système?

Ce système est optimal pour les installations qui répondent aux conditions suivantes :

- Salle de vente jusqu'à 1400 m² avec environ jusqu'à 40kW d'unités de réfrigération
- Température extérieure de travail (DryCooler) maximale de 48°C.

Ce nouveau système nécessite-t-il un projet d'installation?

Le système Waterin ne nécessite pas d'installation frigorifique car il s'agit d'un meuble avec l'unité déjà installée et chargée en usine, bien que sa mise en œuvre dans la salle de vente nécessite un calcul de l'installation du système de condensation de l'eau et de ses composants.

Quels sont les avantages du système Waterin ?

Waterin est un système écologique à condensation par eau qui offre de multiples avantages dans le domaine de la réfrigération commerciale. Une meilleure efficacité énergétique, un impact environnemental réduit et un meilleur contrôle de la température ne sont que quelques-uns de ses avantages.



Waterin

Sistema Waterloop R290 de Infrico

Unidades R290 condensados por agua de Temperatura Positiva.
R290 units, Positive Temperature water condensed.
Unités R290 à condensation par eau à Température Positive.

Unidades R290 condensados por agua de Temperatura Negativa.
R290 units, Negative Temperature water condensed.
Unités R290 à condensation par eau à Température négative.

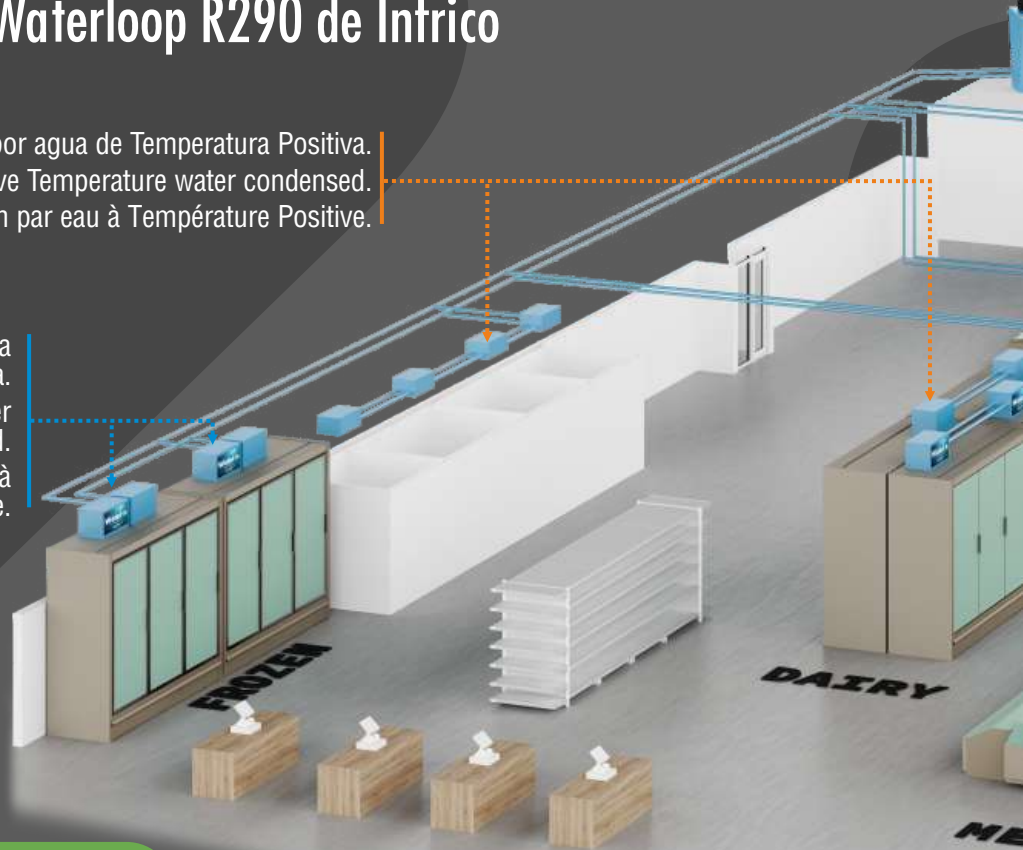

Posibilidad de recuperación de calor para calefacción o agua caliente sanitaria.

Possibility of heat recovery for heating or sanitary hot water.

Possibilité de récupération de chaleur pour le chauffage ou l'eau chaude sanitaire.

Unidades R290 condensados por agua de Temperatura Positiva.
R290 units, Positive Temperature water condensed.
Unités R290 à condensation par eau à Température Positive.

9



VEXW

VEX (9-12-18-25-31-37) W-IW
VEX (9-12-18-25-31-37) WCP-IWCP
VEX (9-12-15-18-25) WCB-IWCB
VEX (90) AAW-ACW-AIW-ACIW
VEX (45) ACW-ACIW
VEX (90) AAWCP-ACWCP-AAIWCP-ACIWCP
VEX (45) ACWCP-ACIWCP

Dry Coolers con grupo hidráulico.
 Dry Coolers with hydraulic power unit.
 Dry Coolers avec unité hydraulique.

Unidades R290 condensados por agua de Temperatura Negativa.
 R290 units, Negative Temperature water condensed.
 Unités R290 à condensation par eau à Température négative.

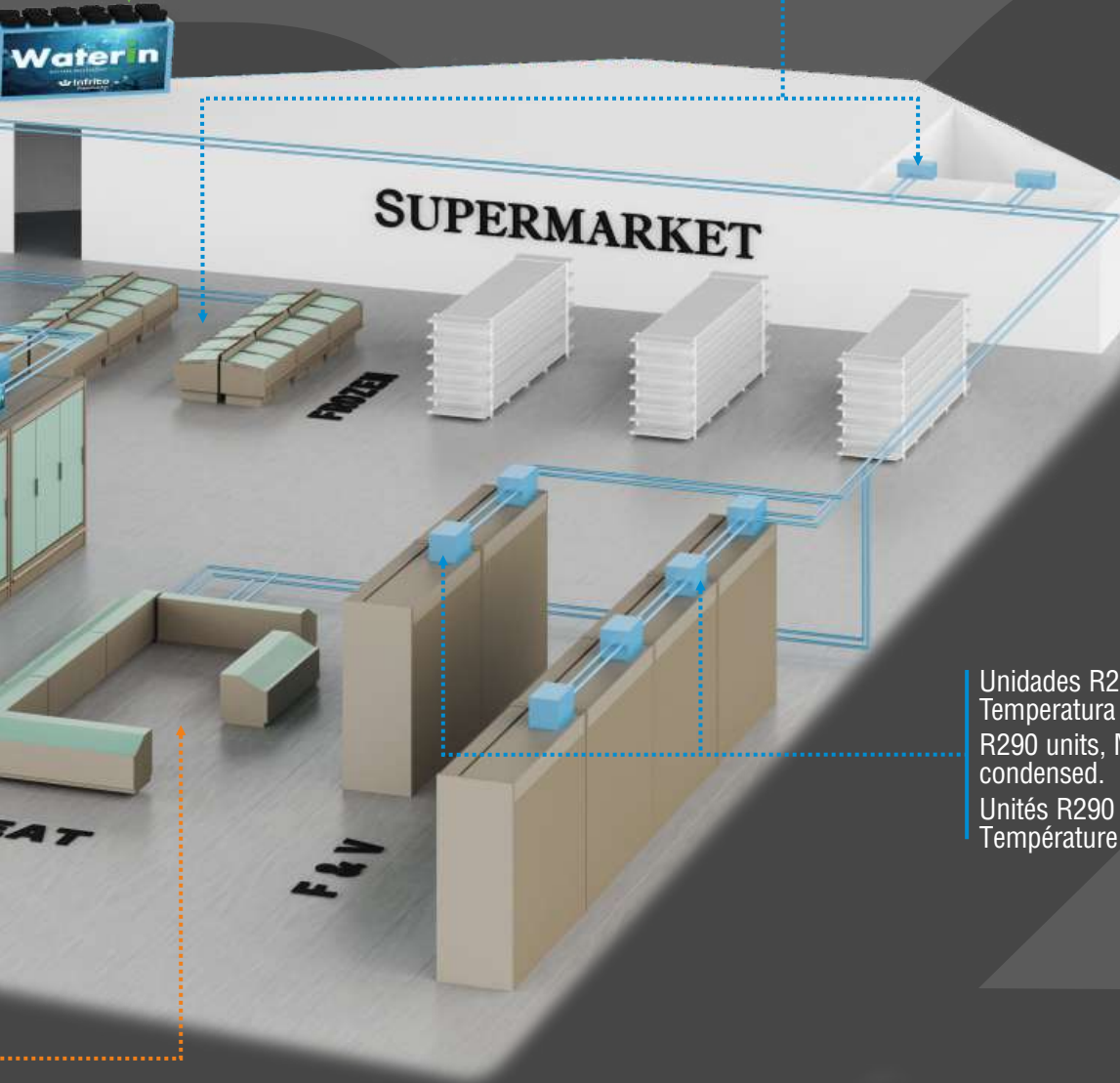

Unidades R290 condensados por agua de Temperatura Negativa.
 R290 units, Negative Temperature water condensed.
 Unités R290 à condensation par eau à Température négative.



GDW

GD25WL1
 GD21WL1
 GDCWL1



AS25W

AS25WL1

Vitrina expositora modular frío ventilado / Refrigerated modular display case / Vitrine présentation froid ventilé canalisable

CARACTERÍSTICAS

- ✦ Puertas tirador doble agarre.
- ✦ Retorno automático, bloqueo apertura 95°.
- ✦ Bultete plano "cleanless".
- ✦ Sistema de ventilación y condensación frontal.
- ✦ Sistema de circulación de aire con efecto Coanda
- ✦ Estructura compacta totalmente inyectada.
- ✦ Gas R290. Zero ODP y Zero GWP.
- ✦ Encimera reforzada con Omegas.

MAIN FEATURES

- ✦ Doors with double handle.
- ✦ Automatic return, 95° opening lock.
- ✦ Flat gasket 'cleanless'.
- ✦ Front ventilation and condensation system.
- ✦ Coanda effect air circulation system.
- ✦ Fully injected compact structure.
- ✦ R290 gas. Zero ODP and Zero GWP.
- ✦ Worktop reinforced with Omegas.

CARACTERISTIQUES

- ✦ Portes avec double poignée.
- ✦ Serrure à retour automatique, ouverture à 95°.
- ✦ Joint d'étanchéité plat « cleanless ».
- ✦ Système de ventilation et de condensation en façade.
- ✦ Système de circulation d'air à effet Coanda.
- ✦ Structure compacte entièrement injectée.
- ✦ Gaz R290, zéro ODP et zéro GWP.
- ✦ Plan de travail renforcé par des Omegas.



VMD 18 RIU

Serie / Series / Série

**VMD
MADRID**

**RU/RIU/SU/SIU: Grupo Incorporado / Plug in / Groupe incorporé
R/RI/S/SI: Grupo Remoto / Remote / Groupe à distance**



CON RESERVA / WHIT STORAGE / AVEC RÉSERVE - RIU/RI: Plano Inox / Stainless Steel exhibition plan / Plan d'exposition Inox

VMD 9 RU/RIU VMD 12 RU/RIU VMD 15 RU/RIU VMD 18 RU/RIU VMD 25 RU/RIU VMD 31 RU/RIU VMD 37 RU/RIU
VMD 9 R/RI VMD 12 R/RI VMD 15 R/RI VMD 18 R/RI VMD 25 R/RI VMD 31 R/RI VMD 37 R/RI

SIN RESERVA / WHITOUT STORAGE / SANS RÉSERVE - SIU/SI: Plano Inox / Stainless Steel exhibition plan / Plan d'exposition Inox

VMD 9 SU/SIU VMD 12 SU/SIU VMD 15 SU/SIU VMD 18 SU/SIU VMD 25 SU/SIU VMD 31 SU/SIU VMD 37 SU/SIU
VMD 9 S/SI VMD 12 S/SI VMD 15 S/SI VMD 18 S/SI VMD 25 S/SI VMD 31 S/SI VMD 37 S/SI



CON RESERVA / WHIT STORAGE / AVEC RÉSERVE MUEBLE CAJA / COUNTER CASE / MEUBLE DE COMPTOIR

RIU/RI: Plano Inox / Stainless Steel exhibition plan / Plan d'exposition Inox VMD 9 C VMD 12 M VMD 15 M
VMD 90 AA RU/RIU VMD 45 AA RU/RIU VMD 90 AC RU/RIU VMD 45 AC RU/RIU
VMD 90 AA R/RI VMD 45 AA R/RI VMD 90 AC R/RI VMD 45 AC R/RI

SIN RESERVA / WHITOUT STORAGE / SANS RÉSERVE

SIU/SI: Plano Inox / Stainless Steel exhibition plan / Plan d'exposition Inox
VMD 90 AA SU/SIU VMD 45 AA SU/SIU VMD 90 AC SU/SIU VMD 45 AC SU/SIU
VMD 90 AA S/SI VMD 45 AA S/SI VMD 90 AC S/SI VMD 45 AC S/SI

Modelos

Serie/Series/Série **VMD MADRID**



VMD 25 RU



VMD 18 SU

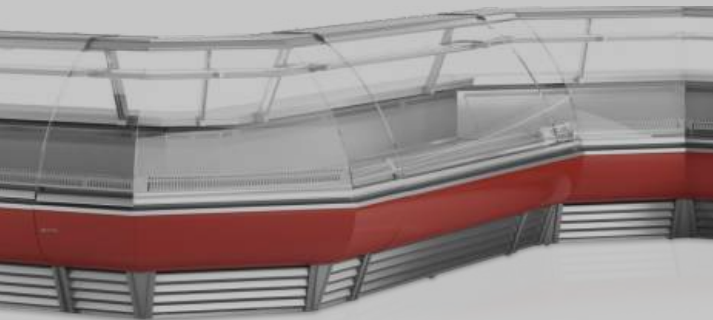

ÁNGULOS / ANGLES / ANGLES VMD



VMD 12 M

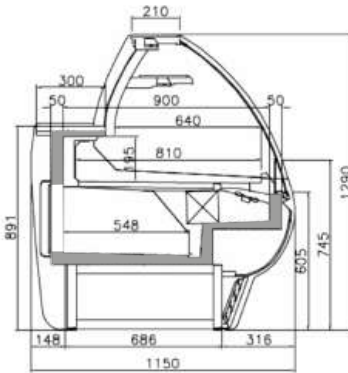

VMD RU/R [con reserva]
[Whit storage]
[Avec réserve]

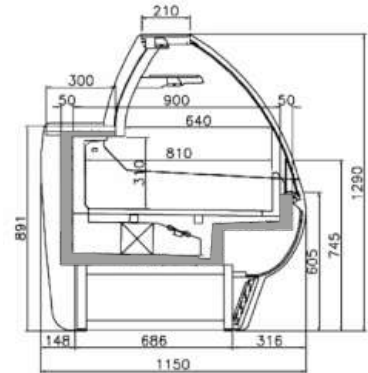

VMD SU/S [Sin reserva]
[Whitout storage]
[Sans réserve]

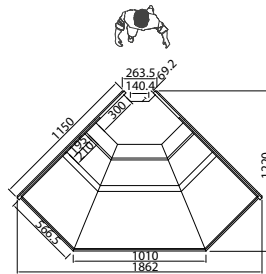

VMD 90 AA

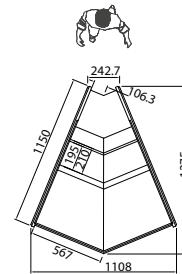

VMD 45 AA

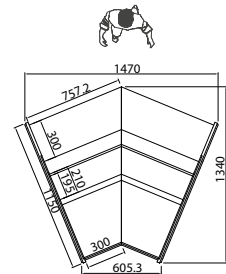

VMD 45 AC

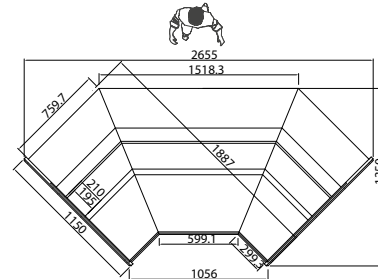

VMD 90 AC



Detalle reserva
Storage detail
Détail réserve

Colores fuera de carta /
Colors outside of letter /
Couleurs spéciales, hors palette

RAL		NO RAL	
Epoxi	Líquida/ Liquid/ Líquide	Epoxi	Líquida/ Liquid/ Líquide
833 €	518 €	Consultar / Consultar / Consultar	
[x unidad/x unit/x unité]			
+10 días laborables / +10 work days / +10 jours ouvrés		Consultar / Consultar / Consultar	

Laterales / Sides / Joues

VMD C/M: SÍ

Laterales / Sides / Joues

VMD 90/45: NO















Izquierdo Left Gauche	Derecho Right Droite
-----------------------------	----------------------------

Ext. Estándar / Standar / Standard

Bianco/White/ Blanc	Ral 1001	Ral 1018	Ral 2003	Ral 3003	Ral 3020
Design 2108025	Ral 5015	Ral 4007	Ral 6002	Design 1107060	Design 3504035
Ral 9006	Ral 7016	Ral 8017			

VMD U

Vitrina expositora modular frío ventilado grupo incorporado / Serie / Series / Série MADRID
 Refrigerated modular plugin display case /
 Vitrine présentation froid ventilé canalisable groupe incorporé

		CON RESERVA / WHIT STORAGE / AVEC RÉSERVE - RIU: Plano Inox / Stainless Steel exhibition plan / Plan d'exposition Inox						
MODELO MODELE MODÈLE								
Precio Price Prix	RU RIU							
		SIN RESERVA / WHITOUT STORAGE / SANS RÉSERVE - SIU: Plano Inox / Stainless Steel exhibition plan / Plan d'exposition Inox						
MODELO MODELE MODÈLE								
Precio Price Prix	SU SIU							
Medidas Measures Mesures	[mm]	938 x 1150 x 1290 mm.	1250 x 1150 x 1290 mm.	1562 x 1150 x 1290 mm.	1875 x 1150 x 1290 mm.	2500 x 1150 x 1290 mm.	3125 x 1150 x 1290 mm.	3750 x 1150 x 1290 mm.
Temperatura Temperature Température	[°C]	0°C/+6°C						
Clase Climática Climatic class Classe climatique	[°C]	4 / 30°C						
Tensión/Frecuencia Electrical data Tension électrique		230V/1ph/50Hz						
Controlador Controller Régulateur		Digital						
Material Matériel	[EXT/INT]	Ext: acero plastificado / Plastified stainless steel / Acier plastifié Encimera / Worktop / Dessous: Inox Aisi 304 Plano exposición / Exhibition plan / Plan d'exposition: Acero plastif. / Plastif. Stainless steel/ Acier plastifié [Mod RU/SU] - Inox Aisi 304 [Mod. RIU/SIU]						
Aislamiento Isolation Isolation		40kg/m ³ / Free CFC's / Zero ODP-GWP						
Capacidad Capacity Capacité	[L]	124	165	206	248	330	413	495
Superficie exposición Surface exhibition Surface d'exposition	[m ²]	0,96	1,28	1,59	1,91	2,55	3,19	3,83
Compresor Compressor Compresseur	[HP]	1/3	1/3	1/2	3/4	1	3/4	3/4
Estantes Shelving Étagères		1						
Costados (2) Sides (2) Joues (2)	[mm]	30+30						
Sistema de frío Cooling System Système de froid		Ventilado / Ventilated / Ventilé						
Desescarche Defrost Dégivrage		Automático / Automatic / Automatique						
Evaporación Evaporation Évaporation		Forzada / Forced / Ventilé						
Potencia Power Puissance	[W]	385	395	530	581	767	1324	1341
Potencia frig. Cooling capacity Puissance Frig.	[W A -10°C]	-	-	-	-	-	-	-
Consumo Consumption Consommation	[kWh/ 24h]	4.61	4.74	6.36	6.98	9.21	15.9	16.1
Refrigerante Refrigerant		R-290						
Opcional Optional Options		Puertas correderas traseras / Rear sliding doors / Portes coulissantes arrière						

Laterales no incluidos en el precio
 Side panels not included in price
 Joues non incluses dans le prix

VMD

Vitrina expositora modular frío ventilado grupo remoto / Serie / Series / Série MADRID

Refrigerated modular display remote case /

Vitrine présentation froid ventilé canalisable groupe à distance

CON RESERVA / WHIT STORAGE / AVEC RÉSERVE - RI: Plano Inox / Stainless Steel exhibition plan / Plan d'exposition Inox

MODELO
MODELE
MODÈLE



Precio Price Prix	R RI							
-------------------------	---------	--	--	--	--	--	--	--

SIN RESERVA / WHITOUT STORAGE / SANS RÉSERVE - SI: Plano Inox / Stainless Steel exhibition plan / Plan d'exposition Inox

MODELO
MODELE
MODÈLE



Precio Price Prix	S SI							
-------------------------	---------	--	--	--	--	--	--	--











Medidas Measures Mesures	(mm)	938 x 1150 x 1290 mm.	1250 x 1150 x 1290 mm.	1562 x 1150 x 1290 mm.	1875 x 1150 x 1290 mm.	2500 x 1150 x 1290 mm.	3125 x 1150 x 1290 mm.	3750 x 1150 x 1290 mm.
Temperatura Temperature Température	(°C)	0°C/+6°C						
Clase Climática Climatic class Classe climatique	(°C)	4 / 30°C						
Tensión/Frecuencia Electrical data Tension électrique		230V/1ph/50Hz						
Controlador Controller Régulateur		Digital						
Material Material Matériel	(EXT/INT)	Ext: acero plastificado / Plastified stainless steel / Acier plastifié Encimera / Worktop / Dessous: Inox Aisi 304 Plano exposición / Exhibition plan / Plan d'exposition: Acero plastif./ Plastif. Stainless steel/ Acier plastifié [Mod R/S] - Inox Aisi 304 [Mod. RI/SI]						
Aislamiento Isolation Isolation		40kg/m ³ / Free CFC's / Zero ODP-GWP						
Capacidad Capacity Capacité	(L)	124	165	206	248	330	413	495
Superficie exposición Surface exhibition Surface d'exposition	(m ²)	0,96	1,28	1,59	1,91	2,55	3,19	3,83
Compresor Compressor Compresseur	(HP)	-	-	-	-	-	-	-
Estantes Shelving Étagères		1						
Costados [2] Sides [2] Joues [2]	(mm)	30+30						
Sistema de frío Cooling System Système de froid		Ventilado / Ventilated / Ventilé						
Desescarche Defrost Dégivrage		Automático / Automatic / Automatique						
Evaporación Evaporation Évaporation		Forzada / Forced / Ventilé						
Potencia Power Puissance	(W)	-	-	-	-	-	-	-
Potencia frig. Cooling capacity Puissance Frig.	(W A -10°C)	556	741	926	1112	1483	1853	2224
Consumo Consumption Consommation	(kWh/ 24h)	-	-	-	-	-	-	-
Refrigerante Refrigerant Gaz		R-290						
Opcional Optional Options								

Laterales no incluidos en el precio
Side panels not included in price
Joues non incluses dans le prix

VMD U

Vitrina expositora modular frío ventilado grupo incorporado /
Refrigerated modular plugin display case /
Vitrine présentation froid ventilé canalisable groupe incorporé

Mueble caja /
Counter case /
Meuble de comptoir

		CON RESERVA / WHIT STORAGE / AVEC RÉSERVE RIU: Plano Inox / Stainless Steel exhibition plan / Plan d'exposition Inox				MUEBLE CAJA / COUNTER CASE / MEUBLE DE COMPTOIR		
MODELO MODELE MODÈLE								
		VMD 90 AA RU/RIU	VMD 45 AA RU/RIU	VMD 90 AC RU/RIU	VMD 45 AC RU/RIU	VMD 9 C	VMD 12 M	VMD 15 M
Precio Price Prix	RU RIU							
		SIN RESERVA / WHITOUT STORAGE / SANS RÉSERVE SIU: Plano Inox / Stainless Steel exhibition plan / Plan d'exposition Inox						
MODELO MODELE MODÈLE						-	-	-
		VMD 90 AA SU/SIU	VMD 45 AA SU/SIU	VMD 90 AC SU/SIU	VMD 45 AC SU/SIU	-	-	-
Precio Price Prix	SU SIU							
Medidas Measures Mesures	[mm]	1326 x 1150 x 1290 mm.	1108 x 1150 x 1290 mm.	1887 x 1150 x 1290 mm.	1470 x 1150 x 1290 mm.	938 x 1150 x 906 mm.	1250 x 1150 x 906 mm.	1562 x 1150 x 906 mm.
Temperatura Temperature Température	[°C]	0°C/+6°C				-		
Clase Climática Climatic class Classe climatique	[°C]	4 / 30°C				-		
Tensión/Frecuencia Electrical data Tension électrique		230V/1ph/50Hz				-		
Controlador Controller Régulateur		Digital				-		
Material Matériel	[EXT/INT]	Ext: acero plastificado / Plastified stainless steel / Acier plastifié Encimera / Worktop / Dessous: Inox Aisi 304 Plano exposición / Exhibition plan / Plan d'exposition: Acero plastif./ Plastif. Stainless steel/ Acier plastifié [Mod RU/SU] - Inox Aisi 304 [Mod. RIU/SIU]						
Aislamiento Isolation Isolation		40kg/m ³ / Free CFC's / Zero ODP-GWP				-		
Capacidad Capacity Capacité	[L]	-	-	-	-	-	-	-
Superficie exposición Surface exhibition Surface d'exposition	[m ²]	1,15	0,63	1,49	0,75	0,55	0,74	0,92
Compresor Compressor Compresseur	[HP]	5/8	3/8	3/4	1/2	-	-	-
Estantes Shelving Étagères		1				-		
Costados (2) Sides (2) Joues (2)	[mm]	30+30						
Sistema de frío Cooling System Système de froid		Ventilado / Ventilated / Ventilé				-		
Desescarche Defrost Dégivrage		Automático / Automatic / Automatique				-		
Evaporación Evaporation Évaporation		Forzada / Forced / Ventilé				-		
Potencia Power Puissance	[W]	990	670	1060	740	-	-	-
Potencia frig. Cooling capacity Puissance Frig.	[W A -10°C]	1096	676	1315	817	-	-	-
Consumo Consumption Consommation	[kWh/ 24h]	13,9	9,4	14,8	10,4	-	-	-
Refrigerante Refrigerant Gaz		R-290				-		
Opcional Optional Options		Puertas corred. tras. / Rear sliding doors / Portes couliss. arrière [PUEV90AACT]	Puertas corred. tras. / Rear sliding doors / Portes couliss. arrière [PUEV45AACT]	Puertas corred. tras. / Rear sliding doors / Portes couliss. arrière [PUEV90ACCT]	Puertas corred. tras. / Rear sliding doors / Portes couliss. arrière [PUEV45ACCT]	-		

Laterales no incluidos en el precio
Side panels not included in price
Joues non incluses dans le prix

Laterales incluidos en el precio
Side panels included in price
Joues incluses dans le prix











VMD

Vitrina expositora modular frío ventilado grupo remoto /
Refrigerated modular display remote case /
Vitrine présentation froid ventilé canalisable groupe à distance

Mueble caja /
Counter case /
Meuble de comptoir

CON RESERVA / WHIT STORAGE / AVEC RÉSERVE
RI: Plano Inox / Stainless Steel exhibition plan / Plan d'exposition Inox

MUEBLE CAJA / COUNTER CASE / MEUBLE DE COMPTOIR

MODELO MODELE MODÈLE								
Precio Price Prix	R							
	RI							
MODELO MODELE MODÈLE	SIN RESERVA / WHITOUT STORAGE / SANS RÉSERVE SI: Plano Inox / Stainless Steel exhibition plan / Plan d'exposition Inox							
					-	-	-	
Precio Price Prix	S							
	SI							
Medidas Measures Mesures	(mm)	1326 x 1150 x 1290 mm.	1108 x 1150 x 1290 mm.	1887 x 1150 x 1290 mm.	1470 x 1150 x 1290 mm.	938 x 1150 x 906 mm.	1250 x 1150 x 906 mm.	1562 x 1150 x 906 mm.
Temperatura Temperature Température	(°C)	0°C/+6°C				-		
Clase Climática Climatic class Classe climatique	(°C)	4 / 30°C				-		
Tensión/Frecuencia Electrical data Tension électrique		230V/1ph/50Hz				-		
Controlador Controller Régulateur		Digital				-		
Material Material Matériel	(EXT/INT)	Ext: acero plastificado / Plastified stainless steel / Acier plastifié Encimera / Worktop / Dessous: Inox Aisi 304 Plano exposición / Exhibition plan / Plan d'exposition: Acero plastif./Plastif. Stainless steel/ Acier plastifié (Mod R/S) - Inox Aisi 304 (Mod. RI/SI)						
Aislamiento Isolation Isolation		40kg/m ³ / Free CFC's / Zero ODP-GWP				-		
Capacidad Capacity Capacité	(L)	-	-	-	-	-	-	-
Superficie exposición Surface exhibition Surface d'exposition	(m ²)	1,15	0,63	1,49	0,75	0,55	0,74	0,92
Compresor Compressor Compresseur	(HP)	-	-	-	-	-	-	-
Estantes Shelving Étagères		1				-		
Costados (2) Sides (2) Joues (2)	(mm)	30+30						
Sistema de frío Cooling System Système de froid		Ventilado / Ventilated / Ventilé				-		
Desescarche Defrost Dégivrage		Automático / Automatic / Automatique				-		
Evaporación Evaporation Évaporation		Forzada / Forced / Ventilé				-		
Potencia Power Puissance	(W)	-	-	-	-	-	-	-
Potencia frig. Cooling capacity Puissance Frig.	(W A -10°C)	780	391	1151	777	-	-	-
Consumo Consumption Consommation	(kWh/ 24h)	-	-	-	-	-	-	-
Refrigerante Refrigerant Gaz		R-290				-		
Opcional Optional Options		Puertas corred. tras. / Rear sliding doors / Portes couliss. arrière (PUEV90AACT)	Puertas corred. tras. / Rear sliding doors / Portes couliss. arrière (PUEV45AACT)	Puertas corred. tras. / Rear sliding doors / Portes couliss. arrière (PUEV90ACCT)	Puertas corred. tras. / Rear sliding doors / Portes couliss. arrière (PUEV45ACCT)	-		

Laterales no incluidos en el precio
Side panels not included in price
Joues non incluses dans le prix

Laterales incluidos en el precio
Side panels included in price
Joues incluses dans le prix

